

Portable Compact Disc Player

Service Service Service

AX5200 AX5201 AX5202 AX5203
AX5210 AX5211 AX5212 AX5215
AX5219
all versions



PRODUCT FAMILY FOCUS – TARGET-5 SERIES

Service Manual



TABLE OF CONTENTS

| | |
|--------------------------------|----------|
| Technical specification | 1-1 |
| Features and Accessories | 1-2 |
| Connections and controls | 1-3 |
| Instruction for use | 1-4..1-6 |
| Safety & Warnings | 1-7 |
| Service hints | |
| Repair positions | 2-1 |
| Dismantling CD-door | 2-1 |
| Handling chip components | 2-2 |
| Service tools | 2-2 |
| Pin description of ICs | 3-1..3-5 |
| Start-up procedure | 3-6 |
| Service Test Program | 3-7..3-8 |
| Blockdiagram | 3-9 |

| | |
|----------------------------|----------|
| Circuit diagrams | |
| Control/support part | 4-1 |
| Audio part | 4-2 |
| CD part | 4-3 |
| Layout diagrams | |
| Componentside view | 4-4 |
| Copperside view | 4-5 |
| Exploded view | 5-1 |
| Mechanical partslist | 5-1 |
| Electrical partslist | 6-1..6-4 |

© Copyright 2001 Philips Consumer Electronics B.V. Eindhoven, The Netherlands
All rights reserved. No part of this publication may be reproduced, stored in a retrieval system or transmitted, in any form or by any means, electronic, mechanical, photocopying, or otherwise without the prior permission of Philips.

Published by LX 0307 Service Audio Printed in The Netherlands Subject to modification

GB 3140 785 32460

**CLASS 1
LASER PRODUCT**



PHILIPS

TECHNICAL SPECIFICATION

General

| | |
|--------------------------|----------------|
| Dimensions (HxD) | :22.8x137.5 mm |
| Weight without batteries | :187g |

Power supply modes

| | |
|---------------------------|--------------|
| DC-in socket | : 2.5 - 6.0V |
| Primary batteries (2xLR6) | : 2.0 - 3.6V |
| Rechargeable batteries | : 2.0 - 3.6V |

Battery lifetime

| BATTERY TYPE | ESP=ON | PSM |
|---|---------------------|---------------------|
| Primary Batteries 2 x LR6 | ≥ 15h (20h typ.) | ≥ 28h (32h typ.) |
| Primary Batteries 2 x AAA | ≥ 7h (9h typ.) | ≥ 13h (15h typ.) |
| Rechargeable Batteries AY3363(1200mAh) | ≥ 4h (6h typ.) | ≥ 10h (12h typ.) |

Battery level detection

| DETECTION LEVEL | Primary bateries | Rechargeable batteries |
|-----------------|---------------------------------------|--------------------------------------|
| Battery empty | 1.8V +100/-50mV | 1.8V +100/-50mV |
| Battery weak 1 | battery empty level + 0.75V ±100mV | battery empty level + 0.7V ±100mV |
| Battery weak 2 | battery empty level + 0.45V ±100mV | battery empty level + 0.5V ±100mV |
| Battery weak 3 | battery empty level + 0.3V ±100mV | battery empty level + 0.3V ±100mV |

Current consumption CDDA-playback

| OPERATION MODE | DC-IN SUPPLY (4.5V) | | BATT. SUPPLY (2.25V) | |
|----------------|---------------------|------------|----------------------|------------|
| | Powersave | ESP=ON | Powersave | ESP=ON |
| Play-mode | 90mA typ. | 110mA typ. | 80mA typ. | 120mA typ. |
| Charge-mode | 220mA typ. | | n/a | |
| Jump-mode | 400mA typ. | | 400mA typ. | |
| Stand-by | 60 mA typ. | | 350 μA typ. | |

Shock resistance

| | |
|-----------------|----------|
| +X/-X direction | : ≥2.5 g |
| +Y/-Y direction | : ≥2.5 g |
| +Z/-Z direction | : ≥2 g |

Headphone out (measured with 16Ω load, DBB/ESP off)

| | |
|-----------------------------------|--------------------------|
| Output power (THD=10%) | |
| /17 version only | : 2x8mW (+1/-3dB) |
| all other versions | : 2x4mW (+2/-2dB) |
| Frequency response (1mW) | : 100Hz-20kHz within 6dB |
| S/N ratio (unwght) | : ≥80dB (82dB typ.) |
| S/N ratio (A-wght) | : ≥82dB (84dB typ.) |
| THD+N (1kHz, 1mW) | : ≤1% (0.2% typ.) |
| Channel crosstalk (1kHz, no load) | : ≤-65dB (-75dB typ.) |
| Channel unbalance (-40dB) | : ≤5dB |
| Volume attenuation (1kHz) | : ≥60dB |

Dynamic Bass Boost DBB

| DBB STAGE | Frequency response | | |
|-----------|--------------------|-----------|-----------|
| | 63Hz | 1kHz | 10kHz |
| DBB | +8dB ± 2dB | 0dB ± 2dB | 0dB ± 2dB |

Laser

| | |
|--------------|-------------------|
| Output power | : <5mW (3mW typ.) |
| Wavelength | : 780nm |

Measurement setup

Use Audio Signal disc SBC429 4822 397 30184

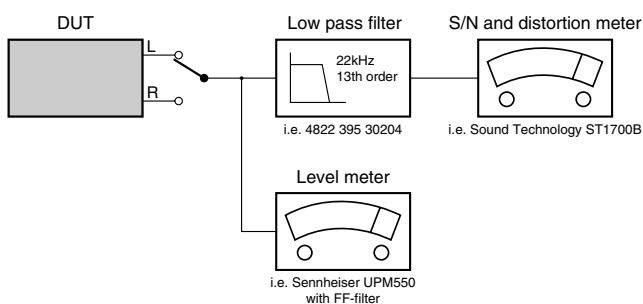

FEATURES

| FEATURES OF CD-PORTABLE | AX5200/00C | AX5201/00C | AX5201/05Z | AX5202/00C | AX5202/01 | AX5202/10 | AX5203/00C | AX5203/05Z | AX5210/17 | AX5211/17 | AX5212/17 | AX5215/17 | AX5219/17 |
|----------------------------|------------|------------|------------|------------|-----------|-----------|------------|------------|-----------|-----------|-----------|-----------|-----------|
| | | | | | | | | | | | | | |
| CD-RW COMPATIBILITY | ● | ● | ● | ● | ● | ● | ● | ● | ● | ● | ● | ● | ● |
| ELECTRONIC SKIP PROTECTION | 45s | 45s | 45s | 45s | 45s | 45s | 45s | 45s | 45s | 45s | 45s | 45s | 45s |
| ESP DRAM SIZE [Mbit] | 16 | 16 | 16 | 16 | 16 | 16 | 16 | 16 | 16 | 16 | 16 | 16 | 16 |
| HOLD / RESUME FUNCTION | ●/● | ●/● | ●/● | ●/● | ●/● | ●/● | ●/● | ●/● | ●/● | ●/● | ●/● | ●/● | ●/● |
| DBB STAGES | 1 | 1 | 1 | 1 | 1 | 1 | 1 | 1 | 1 | 1 | 1 | 1 | 1 |
| ACOUSTIC FEEDBACK | ● | ● | ● | ● | ● | ● | ● | ● | ● | ● | ● | ● | ● |
| PROGRAM MEMORY | 30 | 30 | 30 | 30 | 30 | 30 | 30 | 30 | 30 | 30 | 30 | 30 | 30 |
| RECHARGE NiCd / NiMH | --/-- | --/-- | --/-- | --/-- | --/-- | --/-- | ●/● | ●/● | --/-- | --/-- | --/-- | --/-- | --/-- |
| BELT-CLIP | -- | -- | -- | -- | -- | -- | -- | -- | -- | -- | -- | -- | -- |
| CORD REMOTE CONTROL | ● | ● | ● | ● | ● | ● | ● | ● | -- | -- | -- | ● | ● |
| LINE / OPT. DIGITAL OUTPUT | --/-- | --/-- | --/-- | --/-- | --/-- | --/-- | --/-- | --/-- | --/-- | --/-- | --/-- | --/-- | --/-- |

ACCESSORIES

| ACCESSORIES FOR CD-PORTABLE | | AX5200 | AX5201 | | AX5202 | | AX5203 | | AX5210 | AX5211 | AX5212 | AX5215 | AX5219 |
|---------------------------------------|----------------|--------|--------|------|--------|-----|--------|------|--------|--------|--------|--------|--------|
| | | /00c | /00c | /05z | /00c | /01 | /10 | /00c | /05z | /17 | /17 | /17 | /17 |
| AY3170/00 AC/DC Adaptor | 4822 219 10617 | O | X | | X | | X | | | | | | |
| AY3170/02 AC/DC Adaptor | 4822 219 10676 | | | | X | | | | | | | | |
| AY3170/05 AC/DC Adaptor | 4822 219 10672 | | X | | | | X | | | | | | |
| AY3170/10 AC/DC Adaptor | 4822 219 10681 | | | | | X | | | | | | | |
| AY3170/12 AC/DC Adaptor | 4822 219 10671 | | | | | | | | | | | | |
| AY3273 Pouch | 3140 113 10651 | O | O | O | O | O | O | O | O | O | O | O | X |
| AY3363 Rechargeable Batt. NiMH | 3103 308 84542 | | | | | | X | X | | | | | |
| AY3464 HiFi Cord (3.5mm L-plug→cinch) | 4822 320 11881 | O | O | O | O | O | O | O | O | O | O | O | O |
| AY3501/00 Car Adaptor Cassette | 4822 397 10059 | O | O | O | O | O | O | O | O | O | O | X | O |
| AY3545/17 Car DC/DC Converter | 4822 219 10033 | O | O | O | O | O | O | O | O | O | O | X | O |
| AY3548/17 Car DC/DC Converter | 3140 118 71890 | | | | | | | | | | | X | O |
| AY3778/00 Cord Remote Control | 3140 118 51490 | X | X | X | X | X | X | X | | | | X | X |
| HE570/77s Headphone | 9082 100 01724 | X | X | X | X | X | X | X | | | | | |
| HS383/77 Headphone | 9082 100 02026 | | | | | | | | X | X | X | | |
| HS383/77s Headphone (S-plug) | 9082 100 01821 | | | | | | | | | | | X | X |

X...supplied with the set, O...optional available

CONNECTIONS AND CONTROLS

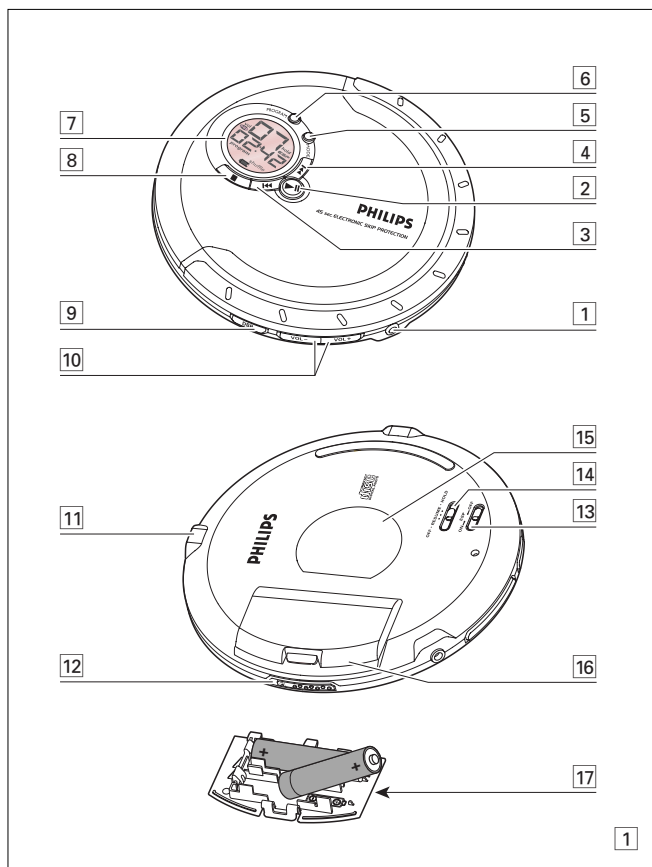

QUICK START

MISE EN SERVICE RAPIDE

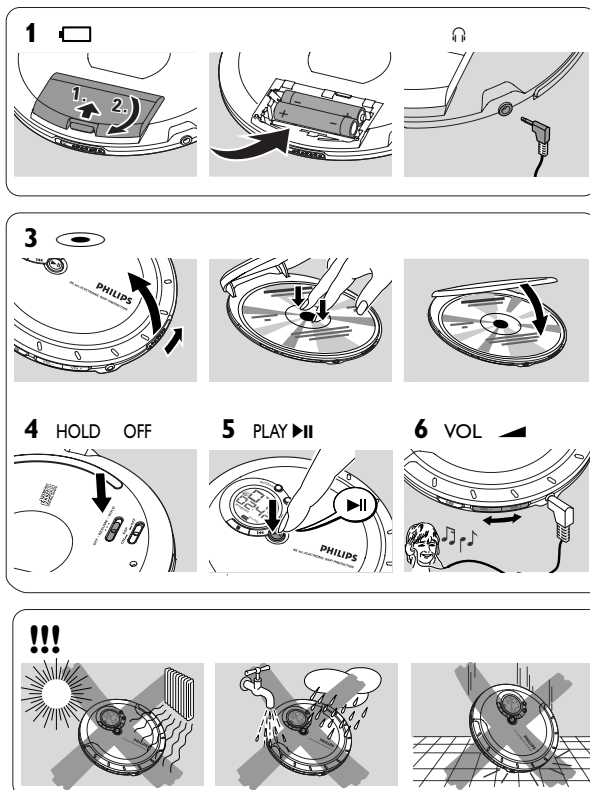

English

CONTROLS / POWER SUPPLY

CONTROLS (see figure 1)

- 1 LINE OUT/.....3.5 mm headphone socket, socket to connect the player to another audio input of an additional appliance, remote control socket (not on all versions)
- 2 ►||.....switches the player on, starts or pauses CD play
- 3 ◀◀.....skips and searches CD tracks backwards
- 4 ▶▶.....skips and searches CD tracks forwards
- 5 MODEselects the different playing possibilities: **shuffle**, **shuffle repeat all**, **repeat**, **repeat all** and **SCAN**
- 6 PROGRAMprograms tracks and reviews the program
- 7display
- 8 ■.....stops CD play, clears a program or switches the player off
- 9 DBB.....switches the bass enhancement on and off. This button also switches acoustic feedback (the beep) on/off when it is pressed for more than 2 seconds
- 10 VOL +/-.....adjusts the volume
- 11 4.5V DC.....socket for external power supply
- 12 OPEN ►.....opens the CD lid
- 13 ESP ON / OFF**ELECTRONIC SKIP PROTECTION** ensures continuous CD playback regardless of vibrations and shocks
- 14 OFF.....switches RESUME and HOLD off
RESUMEstores the last position of a CD track played
HOLD.....locks all buttons
- 15typeplate
- 16battery compartment
- 17AAA battery door

POWER SUPPLY / GENERAL INFORMATION

Average playing time of batteries under normal conditions

| Battery type | ESPOn | PowerSave |
|------------------------------------|----------|-----------|
| Normal AA | 5 hours | 9 hours |
| Normal AAA | 3 hours | 5 hours |
| Alkaline AA | 18 hours | 33 hours |
| Alkaline AAA | 8 hours | 15 hours |
| Rechargeable ECO-PLUS NiMH battery | 7 hours | 12 hours |

Batteries contain chemical substances, so they should be disposed of properly.

ECO-PLUS NiMH battery information (for versions supplied with the rechargeable ECO-PLUS NiMH battery AY 3363)

Recharging works only on players supplied with the rechargeable ECO-PLUS NiMH battery AY 3363.

Recharging the ECO-PLUS NiMH battery on board

- 1 Insert the rechargeable ECO-PLUS NiMH battery AY 3363.
- 2 Connect the mains adapter to the 4.5V DC socket of the player and then to the wall socket.
→ is pulsing.
- Recharging stops after a maximum of 7 hours, or when you start playback.
- 3 When the battery is fully recharged, and **FULL** appears in the display.

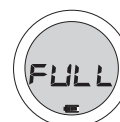

Notes: – It is normal for the batteries to become warm during recharging.
– If the batteries become too warm, recharging will be interrupted for approximately 30 minutes.
– To ensure proper recharging on board, take care that contacts are clean.
– Use only the ECO-PLUS NiMH battery AY 3363.

INSTRUCTION FOR USE

GENERAL INFORMATION

CD player and CD handling

- Do not touch the lens (A) of the CD player.
- Do not expose the unit, batteries or CDs to humidity, rain, sand or excessive heat (caused by heating equipment or direct sunlight).
- You can clean the CD player with a soft, slightly dampened, lint-free cloth. Do not use any cleaning agents as they may have a corrosive effect.
- To clean the CD, wipe it in a straight line from the center toward the edge using a soft, lint-free cloth. A cleaning agent may damage the disc! Never write on a CD or attach a sticker to it.
- The lens may cloud over when the unit is moved suddenly from cold to warm surroundings. Playing a CD is not possible then. Leave the CD player in a warm environment until the moisture has evaporated.
- Active mobile phones in the vicinity of the CD player may cause malfunctions.
- Avoid dropping the unit as this may cause damage.

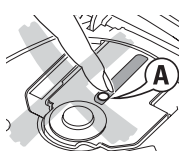

Headphones HE570

- Connect the supplied headphones to the LINE OUT/ear socket of the player.

Note: LINE OUT/ear can also be used for connecting this set to your HiFi system. To adjust the sound and volume, use the controls on the connected audio equipment and on the CD player.

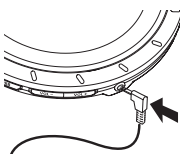

IMPORTANT!

Hearing safety: Do not play your headphones at a high volume. Hearing experts advise that continuous use at high volume can permanently damage your hearing.

Traffic safety: Do not use headphones while driving a vehicle. It may create a hazard and it is illegal in many countries. Even if your headphones are an open-air type designed to let you hear outside sounds, do not turn up the volume so high that you cannot hear what is going on around you.

In-car use (connections supplied or optionally available)

Only use the AY 3545 (4822 219 10033) or AY 3548 (3140 118 71890) car voltage converter (4.5 V DC, positive pole to the centre pin) and the AY 3501 car cassette adapter. Any other product may damage the set.

- 1 Put the set on a horizontal, vibration-free and stable surface. Make sure it is in a safe place, where the set is neither a danger nor an obstacle to the driver and the passengers.
 - 2 Plug the voltage converter into the cigarette lighter socket (**only for 12 V car battery, negative grounding**), then connect the wired end with 4.5V DC input socket on the set.
 - 3 If necessary, clean the cigarette lighter socket to obtain a good electrical contact.
 - 4 Turn down the volume and connect the cassette adapter plug to LINE OUT/ear on the set.
 - 5 Carefully insert the cassette adapter into the car radio's cassette compartment.
 - 6 Make sure the cord does not hinder your driving.
 - 7 Decrease the volume on the set if necessary. Start playback on the set and adjust the sound with the car radio controls.
- **Always remove the voltage converter from the cigarette lighter socket when the set is not in use.**

Note: If your car radio has a LINE IN socket, it is better to use it for the car radio connection instead of the adapter cassette. Connect the signal lead to this LINE IN socket and to LINE OUT/ear on the set.

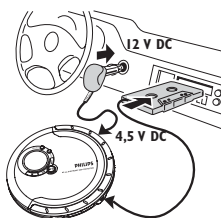

CD PLAY

Playing a CD

This CD-player can play all kinds of **Audio Discs** such as CD-Recordables and CD-Rewritables. Do not try to play a CD-ROM, CDi, VCD, DVD or computer CD.

- 1 Push the OPEN ► slider to open the player.
- 2 Insert an audio CD, printed side up, by pressing the CD onto the hub.
- 3 Close the player by pressing the lid down.
- 4 Press ►► to switch the player on and start playback.
 - The current track number and elapsed playing time are displayed.
- You can pause playback by pressing ►►.
 - The time at which playback was paused starts flashing.
- You can continue playback by pressing ►► again.
- 5 Press ■ to stop playback.
 - The total number of tracks and the total playing time of the CD are displayed.
- 6 Press ■ again to switch the player off.

Note: If there is no activity, the set will automatically switch off after a while to save energy.

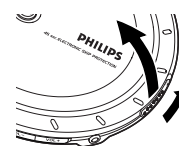

Playback information

- If a CD-Recordable (CD-R) or a CD-Rewritable (CD-RW) is not recorded properly, **FF d 15C** is displayed, indicating that the CD has not been finalized. In that case, use FINALIZE on your CD recorder to complete the recording.
- When playing a CD-Rewritable (CD-RW), please note that it takes 3–15 seconds after pressing ►► for sound reproduction to start.
- Playback will stop if you open the CD lid.
- While the CD is read, **---** flashes in the display.



Volume and bass

Volume adjustment

- Adjust the volume by using VOL +/-.

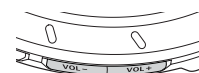

Bass adjustment

- Press DBB to switch the bass enhancement on or off.
 - **DBB** is shown if the bass enhancement is activated.

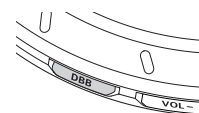

Remote control (for some versions only)

Use the AY 3768 / AY3778 cord remote control. The buttons on the remote control have the same functions as the corresponding buttons on the set.

- 1 Press ■ twice to switch off the set.
- 2 Firmly connect the remote control to LINE OUT/ear on the set.
- 3 Adjust the volume on the CD player and remote control.



INSTRUCTION FOR USE

FEATURES

Selecting a track and searching

Selecting a track during playback

- Briefly press **◀** or **▶** once or several times to skip to the current, previous or next track.
 - ▶ Playback continues with the selected track, and the track's number is displayed.



Selecting a track when playback is stopped

- Briefly press **◀** or **▶** once or several times to select the desired track. The track number is displayed.
- Press **▶||** to start CD play.
 - ▶ Playback starts with the selected track.

Searching for a passage during playback

- Keep **◀** or **▶** pressed to find a particular passage in a backward or forward direction.
 - ▶ Searching starts while playback continues at low volume. After 2 seconds the search speeds up.
- Release the button when you reach the desired passage.
 - ▶ Playback continues from this position.

Notes: – If the player is in SCAN mode (see MODE chapter), searching is not possible.
 – In shuffle, shuffle repeat all or repeat mode (see MODE chapter), or while playing a program, searching is only possible within the particular track.

Programming track numbers

You can store up to 30 tracks to play in a program. A single track may be stored more than once in the program.

- While playback is stopped, select a track with **◀** or **▶**.
 - Press PROGRAM to store the track.
 - ▶ **program** lights up; the track number programmed and **P** with the total number of stored tracks are displayed.
 - Select and store all desired tracks in this way.
 - Press **▶||** to start playback of your selected tracks.
 - ▶ **program** is shown and playback starts.
- You can review the program by pressing PROGRAM for more than 2 seconds.
 - ▶ The display shows all the stored tracks in sequence.



Notes: – If you press PROGRAM and there is no track selected, **5 E L** is displayed.
 – If you try to store more than 30 tracks, **F U L** is displayed.

Clearing the program

- While playback is stopped, press **■** to clear program.
 - ▶ **CLF** is displayed once, **program** goes off, and the program is cleared.



Note: The program will also be cleared if the power supply is interrupted, or if the CD-player lid is opened, or if the set switches off automatically.

FEATURES

Selecting different playing possibilities MODE

It is possible to play tracks in random order, to repeat a single track or the entire CD, and to play the first few seconds of each track.

- Press MODE during playback as often as required in order to activate one of the following 'modes'. The active mode is shown in the display.
 - ▶ **shuffle**: All tracks of the CD are played in random order until all of them have been played once.
 - ▶ **shuffle repeat all**: All tracks of the CD are played repeatedly in random order.
 - ▶ **repeat**: The current track is played repeatedly.
 - ▶ **repeat all**: The entire CD is played repeatedly.
 - ▶ **5 S E C**: The first 10 seconds of each of the remaining tracks are played in sequence.
- Playback starts in the chosen mode after 2 seconds.



- To return to normal playback, press MODE repeatedly until the display shows no active modes.

ESP / Power Save Mode

With a conventional portable CD-player you might have experienced that the music stopped e.g. when you were jogging. The **ELECTRONIC SKIP PROTECTION** prevents loss of sound caused by light vibrations and shocks. Continuous playback is ensured. However ESP does not prevent playback interruptions during vigorous running. It also does not protect the unit against any **damage** caused by **dropping!**

- Switch the slider to ESP ON during playback to activate the shock protection.
 - ▶ **ESP** is shown and the protection is activated.
- To deactivate the shock protection, switch the slider to OFF.
 - ▶ **ESP** goes off and the protection is deactivated.

ESP on → **Power Save** → **ESP on**

RESUME and HOLD

You can interrupt playback and continue (even after an extended period of time) from the position where playback stopped (RESUME) and you can lock all buttons of the set so that no action will be executed (HOLD). Use the OFF-RESUME-HOLD slider for these functions.

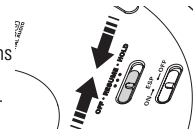

RESUME – continuing from where you have stopped

- Switch the slider to RESUME during playback to activate RESUME.
 - ▶ **resume** is shown.
 - Press **■** whenever you want to stop playback.
 - Press **▶||** whenever you want to resume playback.
 - ▶ **resume** is shown and playback continues from where you have stopped.
- To deactivate RESUME, switch the slider to OFF.
 - ▶ **resume** goes off.



HOLD – locking all buttons

You can lock the buttons of the set by switching the slider to HOLD. Now, when a key is pressed, no action will be executed. This is of use, for example, when transporting the player in a bag. With HOLD activated, you can avoid accidental activation of other functions.

- Switch the slider to HOLD to activate HOLD.
 - ▶ All buttons are locked **HOLD** is shown when you press any button. If the set is switched off, **HOLD** will be shown only when **▶||** is pressed.
- To deactivate HOLD, switch the slider to OFF.



Note: If you deactivate HOLD by switching the slider to RESUME, you will be activating the RESUME function.

INSTRUCTION FOR USE

Batteries (supplied or optionally available)

You can use the following batteries with this CD-player:

- alkaline batteries type **AAA (LR03, UM4)** or **AA (LR6, UM3)** preferably Philips.

Notes:— Old and new or different types of batteries should not be combined.

— Remove batteries if they are empty or if the player is not going to be used for a long time.

Inserting AAA (LR03, UM4) or AY 3363 batteries

- Open the **AAA** battery door.
- Insert **AAA** batteries as shown onto the back of the door.
- Replace the battery-loaded **AAA** door back onto the set.

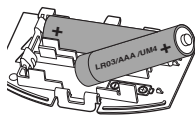

AAA (LR03, UM4)

Inserting AA (LR6, UM3) batteries

To double playback time, insert **AA** batteries into the battery compartment and use the **AA** marked battery door.

- Open the battery compartment and insert either 2 normal or alkaline batteries.

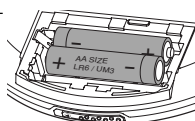

AA (LR6, UM3)

Battery indication

The approximate power level of your batteries is shown in the display.

- Battery full
- Battery two-thirds full
- Battery one-third full
- Battery dead or empty. When the batteries are dead or empty, the symbol flashes, *NO BATT* is displayed, and the beep tone sounds repeatedly.



TROUBLESHOOTING

Troubleshooting

WARNING: Under no circumstances should you try to repair the set yourself as this will invalidate the warranty. If a fault occurs, first check the points listed, before taking the unit for repair. If you are unable to solve a problem by following these hints, consult your dealer or service center.

The CD player has no power, or playback does not start

- Check that your batteries are not dead or empty, that they are inserted correctly, that the contact pins are clean.
- Your adapter connection may be loose. Connect it securely.
- For *in-car use*, check that the car ignition is on. Also check player's batteries.

The indication *NO d 15 C* is displayed

- Check that the CD is clean and correctly inserted (label-side upward).
- If your lens has steamed up, wait a few minutes for this to clear.

The indication *RF d 15 C* is displayed

- CD-RW (CD-R) was not recorded properly. Use FINALIZE on your CD-recorder.

The indication **HOLD** is on and/or there is no reaction to controls

- If **HOLD** is activated, then deactivate it.
- Electrostatic discharge. Disconnect power or remove batteries for a few seconds.

The CD skips tracks

- The CD is damaged or dirty. Replace or clean the CD.
- RESUME, SHUFFLE or PROGRAM is active. Switch off whichever is on.

Handling instructions

- Recharging already charged or half-charged batteries will shorten their lifetime. We therefore recommend that you let the rechargeable ECO-PLUS NiMH battery run till it is completely empty before you recharge it.
- To avoid a short circuit, do not let the battery touch any metal object.
- If the battery becomes empty soon after recharging, then either its contacts are dirty or it has reached the end of its lifetime.

Mains adapter (supplied or optionally available)

Use only the AY 3170 adapter (4.5 V / 300 mA direct current, positive pole to the center pin). Any other product may damage the player.

- Make sure the local voltage corresponds to the power adapter's voltage.
- Connect the power adapter to the 4.5V DC socket of the player and to the wall socket.

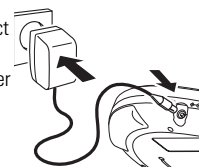

Note: Always disconnect the adapter when you are not using it.

Environmental information

- All redundant packing material has been omitted. We have done our utmost to make the packaging easily separable into two mono materials: cardboard (box) and polyethylene (bags, protective foam sheet).
- Your set consists of materials which can be recycled if disassembled by a specialized company. Please observe the local regulations regarding the disposal of packing materials, exhausted batteries and old equipment.

Troubleshooting

No sound or bad sound quality.

- PAUSE might be active. Press **II**.
- Loose, wrong or dirty connections. Check and clean connections.
- Volume might not be appropriately adjusted. Adjust the volume.
- Strong magnetic fields. Check player's position and connections. Also keep away from active mobile phones.
- For *in-car use*, check that the cassette adapter is inserted correctly, that the car cassette player's playback direction is correct (press autoreverse to change), and that the cigarette lighter jack is clean. Allow time for temperature change.

CAUTION

Use of controls or adjustments or performance of procedures other than herein may result in hazardous radiation exposure or other unsafe operation.

SAFETY & WARNINGS

ⒼⒷ WARNING

All ICs and many other semiconductors are susceptible to electrostatic discharges (ESD). Careless handling during repair can reduce life drastically.

When repairing, make sure that you are connected with the same potential as the mass of the set via a wristband with resistance. Keep components and tools at this potential.

ⒻⒻ ATTENTION

Tous les IC et beaucoup d'autres semi-conducteurs sont sensibles aux décharges statiques (ESD). Leur longévité pourrait être considérablement écourtée par le fait qu'aucune précaution n'est prise à leur manipulation.

Lors de réparations, s'assurer de bien être relié au même potentiel que la masse de l'appareil et enfilez le bracelet sertit d'une résistance de sécurité

Veiller à ce que les composants ainsi que les outils que l'on utilise soient également à ce potentiel.

ESD

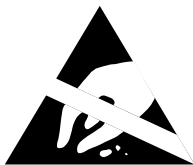

ⒻⒻ WARNING

Alle ICs und viele andere Halbleiter sind empfindlich gegenüber elektrostatischen Entladungen (ESD). Unsorgfältige Behandlung im Reparaturfall kann die Lebensdauer drastisch reduzieren.

Sorgen Sie dafür, daß Sie im Reparaturfall über ein Pulsarmband mit Widerstand mit dem Massepotential des Gerätes verbunden sind.

Halten Sie Bauteile und Hilfsmittel ebenfalls auf diesem Potential.

ⒼⒻ WAARSCHUWING

Alle IC's en vele andere halfgeleiders zijn gevoelig voor electrostatische ontladingen (ESD).

Onzorgvuldig behandelen tijdens reparatie kan de levensduur drastisch doen verminderen. Zorg ervoor dat u tijdens reparatie via een polsband met weerstand verbonden bent met hetzelfde potentiaal als de massa van het apparaat.

Houd componenten en hulpmiddelen ook op ditzelfde potentiaal.

ⒻⒻ AVVERTIMENTO

Tutti IC e parecchi semi-conduttori sono sensibili alle scariche statiche (ESD).

La loro longevità potrebbe essere fortemente ridotta in caso di non osservazione della più grande cauzione alla loro manipolazione. Durante le riparazioni occorre quindi essere collegato allo stesso potenziale che quello della massa delapparecchio tramite un braccialetto a resistenza.

Assicurarsi che i componenti e anche gli utensili con quali si lavora siano anche a questo potenziale.

ⒼⒷ AVAILABLE ESD PROTECTION EQUIPMENT :

anti-static table mat large 1200x650x1.25mm
small 600x650x1.25mm

anti-static wristband

connection box (3 press stud connections, 1MΩ)

extendible cable (2m, 2MΩ, to connect wristband to connection box)

connecting cable (3m, 2MΩ, to connect table mat to connection box)

earth cable (1MΩ, to connect any product to mat or to connection box)

KIT ESD3 (combining all 6 prior products - small table mat)

wristband tester

4822 466 10953

4822 466 10958

4822 395 10223

4822 320 11307

4822 320 11305

4822 320 11306

4822 320 11308

4822 310 10671

4822 344 13999

ⒼⒷ

Safety regulations require that the set be restored to its original condition and that parts which are identical with those specified be used.

Safety components are marked by the symbol

ⒻⒻ

Les normes de sécurité exigent que l'appareil soit remis à l'état d'origine et que soient utilisées les pièces de rechange identiques à celles spécifiées.

Les composants de sécurité sont marqués

SAFETY



ⒻⒻ

Bei jeder Reparatur sind die geltenden Sicherheitsvorschriften zu beachten. Der Originalzustand des Gerätes darf nicht verändert werden. Für Reparaturen sind Originalersatzteile zu verwenden.

Sicherheitsbauteile sind durch das Symbol

ⒼⒻ

Veiligheidsbepalingen vereisen, dat het apparaat in zijn oorspronkelijke toestand wordt teruggebracht en dat onderdelen, identiek aan de gespecificeerde, worden toegepast. De Veiligheidsonderdelen zijn aangeduid met het symbool

ⒻⒻ

Le norme di sicurezza estigono che l'apparecchio venga rimesso nelle condizioni originali e che siano utilizzati i pezzi di ricambio identici a quelli specificati.

Componenti di sicurezza sono marcati con

ⒼⒷ

DANGER: Invisible laser radiation when open. AVOID DIRECT EXPOSURE TO BEAM.



ⒻⒻ Varning !

Osynlig laserstrålning när apparaten är öppnad och spårren är urkopplad. Betrakta ej strålen.

ⒻⒻ Advarsel !

Usynlig laserstrålning ved åbning når sikkerhedsafbrydere er ude af funktion. Undgå udsættelse for strålning.

ⒻⒻ Varoitus !

Avatussa laitteessa ja suojalukituksen ohitettaessa olet alttiina näkymättömälle laserisäteilylle. Älä katso säteeseen !

ⒼⒷ

After servicing and before returning the set to customer perform a leakage current measurement test from all exposed metal parts to earth ground, to assure no shock hazard exists.

The leakage current must not exceed 0.5mA.

ⒻⒻ

"Pour votre sécurité, ces documents doivent être utilisés par des spécialistes agréés, seuls habilités à réparer votre appareil en panne".

SERVICE HINTS

REPAIR POSITION COPPERSIDE

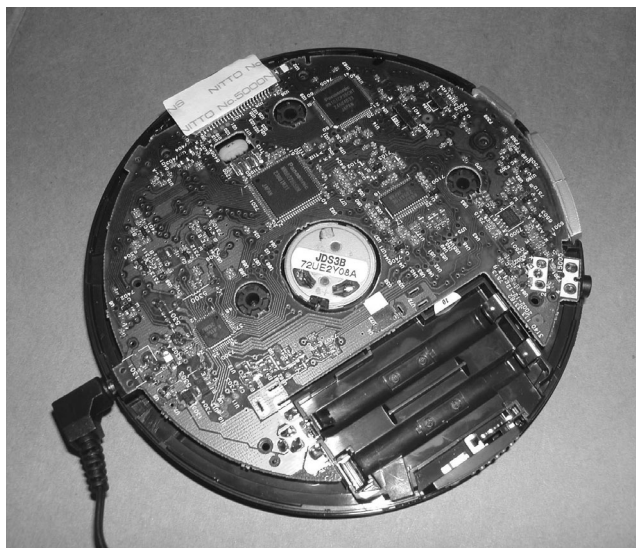

To get access to the copperside of the printed board assembly proceed as follows:

1. Remove the bottom (3x) screws (2x of them under the rubber-foot) and the up (2x) screws (in the CD-door)
2. Lift the bottom -cabinet
3. Supply the unit via external DC-socket
4. Take care that the door switch is closed during measurements

DISMANTLING THE CD-DOOR



To dismantle the CD-door proceed as follows:

1. Dismantle bottom and printed board/drive assembly
2. Disconnect the sticker (flex-foil connector on the membrane keyboard)
3. Disconnect membrane keyboard (flex-foil connector on copperside of printed board)

REPAIR POSITION COMPONENTSIDE



To get access to the componentside of the printed board assembly proceed as followed:

1. Remove the bottom (3x) screws (2x of them under the rubber-foot) and the up (2x) screws (in the CD-door)
2. Open the CD-door
3. Lift the top-cabinet and put it backwards on the table
4. Supply the unit via the external DC-socket
5. Take care that the door switch is closed during measurements

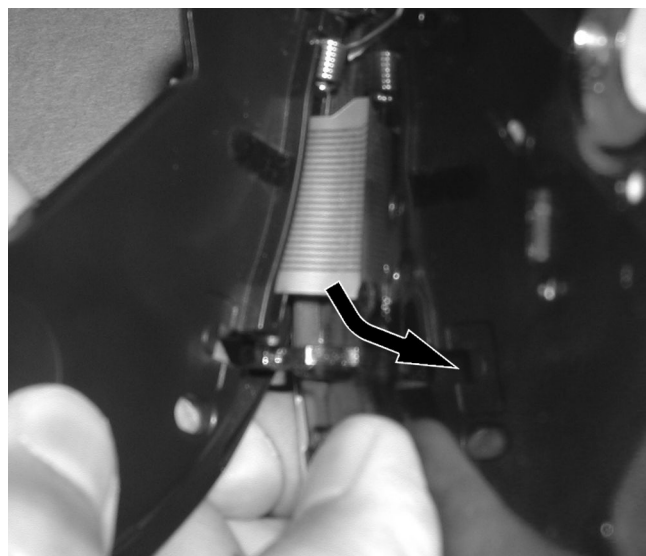

4. Bend the cabinet rightwards downwards as indicated in the picture above

Remark: Do not use screwdrivers or tools .
Sharp edges could damage hinge or cabinet part.

HANDLING CHIP COMPONENTS

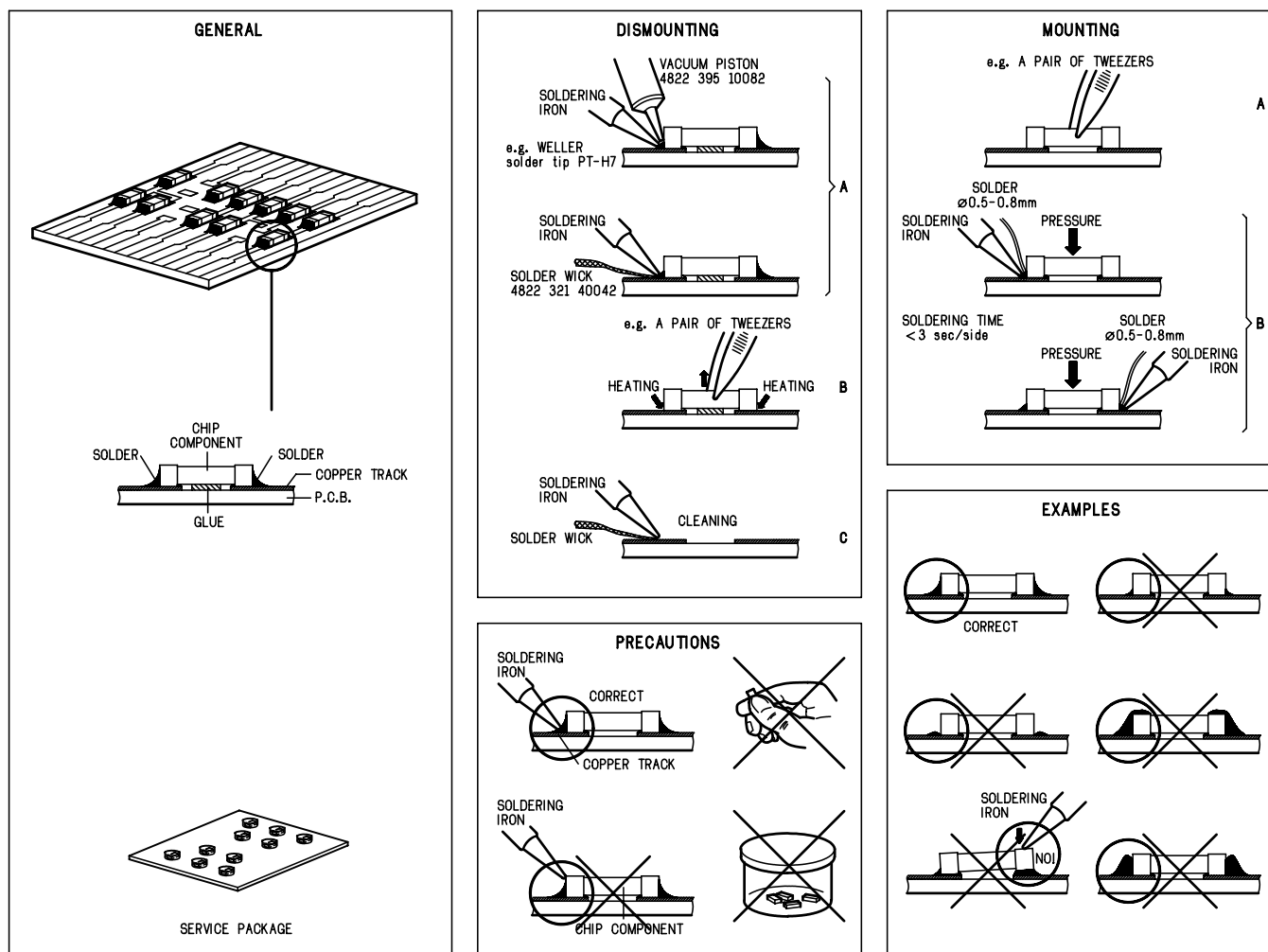

SERVICE TOOLS

Audio signal disc SBC429

4822 397 30184

Playability test disc SBC444

4822 397 30245

Test disc 5 (disc without errors) + **Test disc 5A** (disc with dropout errors
black spots and fingerprints) **SBC426/ SBC426A**

4822 397 30096

ESD PROTECTION EQUIPMENT

Anti-static table mat large 1200x650x1.25mm
small 600x650x1.25mm

4822 466 10953

4822 466 10958

Anti-static wristband

4822 395 10223

Connection box (3press stud connections, 1MΩ)

4822 320 11307

Extendible cable (2m, 2MΩ, to connect wristband to connection box)

4822 320 11305

Connecting cable (3m, 2MΩ, to connect table mat to connection box)

4822 320 11306

Earth cable (1MΩ, to connect any product to mat or to connection box)

4822 320 11308

KIT ESD3 (combining all 6 prior products - small table mat)

4822 310 10671

Wristband tester

4822 344 13999

PIN DESCRIPTION OF INTEGRATED CIRCUITS

MN662786SB – SIGNAL PROCESSING IC

| Pin | Name | I/O | Description |
|-----|---------|-----|--|
| 1 | DRVDD | I | Power supply for DRAM interface (Pin 2 to 19, and 80) |
| 2 | D0 | I/O | DRAM data I/O signal 0 |
| 3 | D1 | I/O | DRAM data I/O signal 1 |
| 4 | NWE | O | DRAM write enable signal |
| 5 | NRAS | O | DRAM RAS control signal |
| 6 | D2 | I/O | DRAM data I/O signal 2 |
| 7 | D3 | I/O | DRAM data I/O signal 3 |
| 8 | NCAS0 | O | DRAM CAS control signal 0 |
| 9 | NCAS1 | O | DRAM CAS control signal 1 |
| 10 | A8 | O | DRAM address signal 8 |
| 11 | A7 | O | DRAM address signal 7 |
| 12 | A6 | O | DRAM address signal 6 |
| 13 | A5 | O | DRAM address signal 5 |
| 14 | A4 | O | DRAM address signal 4 |
| 15 | A9 | O | DRAM address signal 9 |
| 16 | A0 | O | DRAM address signal 0 |
| 17 | A1 | O | DRAM address signal 1 |
| 18 | A2 | O | DRAM address signal 2 |
| 19 | A3 | O | DRAM address signal 3 |
| 20 | DVSS2 | I | Ground for digital circuits |
| 21 | DVDD2 | I | Power supply for digital circuits |
| 22 | SPOUT | O | Spindle motor drive signal output (Absolute value output) |
| 23 | TRVP | O | Traverse drive output (+side output) |
| 24 | TRVM | O | Traverse drive output (-side output) |
| 25 | TRP | O | Traverse drive output (+side output) |
| 26 | TRM | O | Traverse drive output (-side output) |
| 27 | FOP | O | Focus drive output (+side output) |
| 28 | FOM | O | Focus drive output (-side output) |
| 29 | IOVDD1 | I | I/O power supply |
| 30 | TBAL | O | Tracking balance adjustment output |
| 31 | FBAL | O | Focus balance adjustment output |
| 32 | FE | I | Focus error signal input (Analog input) |
| 33 | TE | I | Tracking error signal input (Analog input) |
| 34 | RFENV | I | RF envelope signal input (Analog input) |
| 35 | OFT | I | Off-track signal input H: Off track |
| 36 | NRFDET | I | RF detection signal input L: Detect |
| 37 | BDO | I | Dropout signal input H: Dropout |
| 38 | LDON | O | Laser ON signal output H: ON |
| 39 | ARF | I | RF signal input |
| 40 | IREF | I | Reference current input |
| 41 | ADPVCC | I | A/D converter reference voltage input (Analog input) |
| 42 | DSLFL | O | DSL loop filter |
| 43 | DRFL | I | DSL bias |
| 44 | PLLFL | O | PLL loop filter |
| 45 | VCOFL | O | Jitter-free VCO loop filter |
| 46 | AVDD2 | I | Power supply for analog circuits (For DSL, PLL, VCOFL, A/D converter, and D/A converter) |
| 47 | AVSS2 | I | Ground for analog circuits (For DSL, PLL, VCOFL, A/D converter, and D/A converter) |
| 48 | OUTL | O | L-ch audio output |
| 49 | AVSS1 | I | Ground for analog circuit (For audio output stage) |
| 50 | OUTR | O | R-ch audio output |
| 51 | AVDD1 | I | Power supply for analog circuits (For audio output stage) |
| 52 | FSEL | I | Noise filter for microcontroller interface ON/OFF selection input L:ON H:OFF |
| 53 | TMOD1 | I | Test input pin Normal: L |
| 54 | TMOD2 | I | Test input pin Normal: L |
| 55 | *FLAG | O | Flag signal output |
| 56 | *IPFLAG | O | Interpolation flag signal output H: Interpolation |
| 57 | *EXT0 | I/O | Expansion I/O port 0 |
| 58 | *EXT1 | I/O | Expansion I/O port 1 |
| 59 | IOVDD2 | I | I/O power supply |
| 60 | TX | O | Digital audio interface signal output |
| 61 | MCLK | I | Microcontroller command clock signal input (Latches the data at a rising edge) |
| 62 | MDATA | I | Microcontroller command data signal input |
| 63 | MLD | I | Microcontroller command load signal input L: Load |
| 64 | *BLKCK | O | Subcode block clock signal output f=75 Hz (Normal-speed playback) |
| 65 | PWMSEL | I/O | PWM output mode selection input L: Direct H: 3-state |
| 66 | SMCK | O | 4.236-MHz/8.4672-MHz clock signal output |
| 67 | DMUTE | I/O | Muting input H: Mute |
| 68 | STAT | O | Status signal output |
| 69 | NRST | I | Reset input L: Reset |

| <i>Pin</i> | <i>Name</i> | <i>I/O</i> | <i>Description</i> |
|------------|-------------|------------|--|
| 70 | *SPPOL | O | Spindle motor drive signal output (Polarity output) |
| 71 | PMCK | O | 88.2-KHz clock signal output |
| 72 | *NCLDCK | O | Frame sync signal output f=7.35kHz (Normal-speed playback) |
| 73 | *SUBC | O | Subcode serial output |
| 74 | *SBCK | I | Subcode serial output clock input |
| 75 | NTEST | I | Test input pin Normal: H |
| 76 | X2 | O | Crystal oscillator output pin f=16.9344 MHz |
| 77 | X1 | I | Crystal oscillator input pin f=16.9344 MHz |
| 78 | DVSS1 | I | Ground for digital circuits |
| 79 | DVDD1 | I | Power supply for digital circuits |
| 80 | *EXT2 | I | Expansion I/O part 2 |

AN41502 – DC-DC CONVERTER AND 4-CHANNEL PWM DRIVER

| <i>Pin</i> | <i>Name</i> | <i>Description</i> |
|------------|-------------|---|
| 1 | EMP | Low battery detection output |
| 2 | RESET | Reset output |
| 3 | OFF | DDC turning off |
| 4 | PREGND | Ground for control circuit block |
| 5 | EO | Step-up/down DDC error amplifier output |
| 6 | EI | Step-up/down DDC error amplifier input |
| 7 | SVcc | Step-up/down DDC error supply output |
| 8 | CRP | Ripple filter capacitor output |
| 9 | AVcc | Ripple filter connection |
| 10 | VSUBIN | Sub DDC error amplifier input |
| 11 | VSUB | Sub DDC power supply output |
| 12 | SSW | Sub DDC coil drive |
| 13 | SVccF | Step-up/down DDC power supply |
| 14 | USW | Step-up/down DDC coil drive 2 |
| 15 | PGND1 | Ground for power supply block1 |
| 16 | DSW | Step-up/down DDC coil derive 1 |
| 17 | PVcc1 | Battery power supply input |
| 18 | VSEN | Battery voltage detection input |
| 19 | START | DDC startup |
| 20 | LG | VG voltage step-up coil drive |
| 21 | VG | Gate drive power supply |
| 22 | REGB | REG transistor drive |
| 23 | PVcc2 | AC adapter power supply input |
| 24 | VCNT | Setting PVcc1 for charging |
| 25 | FO4 | Ch.4 forward output |
| 26 | RO4 | Ch.4 reverse output |
| 27 | DRGND2 | Motor ground 2 |
| 28 | FO3 | Ch.3 forward output |
| 29 | RO3 | Ch.3 reverse output |
| 30 | Vm | Motor power supply |
| 31 | RO2 | Ch.2 reverse output |
| 32 | FO2 | Ch.2 forward output |
| 33 | DRGND1 | Motor ground 1 |
| 34 | RO1 | Ch.1 reverse output |
| 35 | FO1 | Ch.1 forward output |
| 36 | MON | Vm monitoring |
| 37 | FI1 | Ch.1 forward input |
| 38 | RI1 | Ch.1 reverse input |
| 39 | FI2 | Ch.2 forward input |
| 40 | RI2 | Ch.2 reverse input |
| 41 | FI3 | Ch.3 forward input |
| 42 | RI3 | Ch.3 reverse input |
| 43 | FI4 | Ch.4 forward input |
| 44 | RI4 | Ch.4 reverse input |
| 45 | CLK | DDC external clock input |
| 46 | SOFT | Soft start setting |
| 47 | CT | Triangular wave output |
| 48 | SPRT | Power off time constant setting |

MN101C39C-399 - MICROCOMPUTER BLOCK DIAGRAM

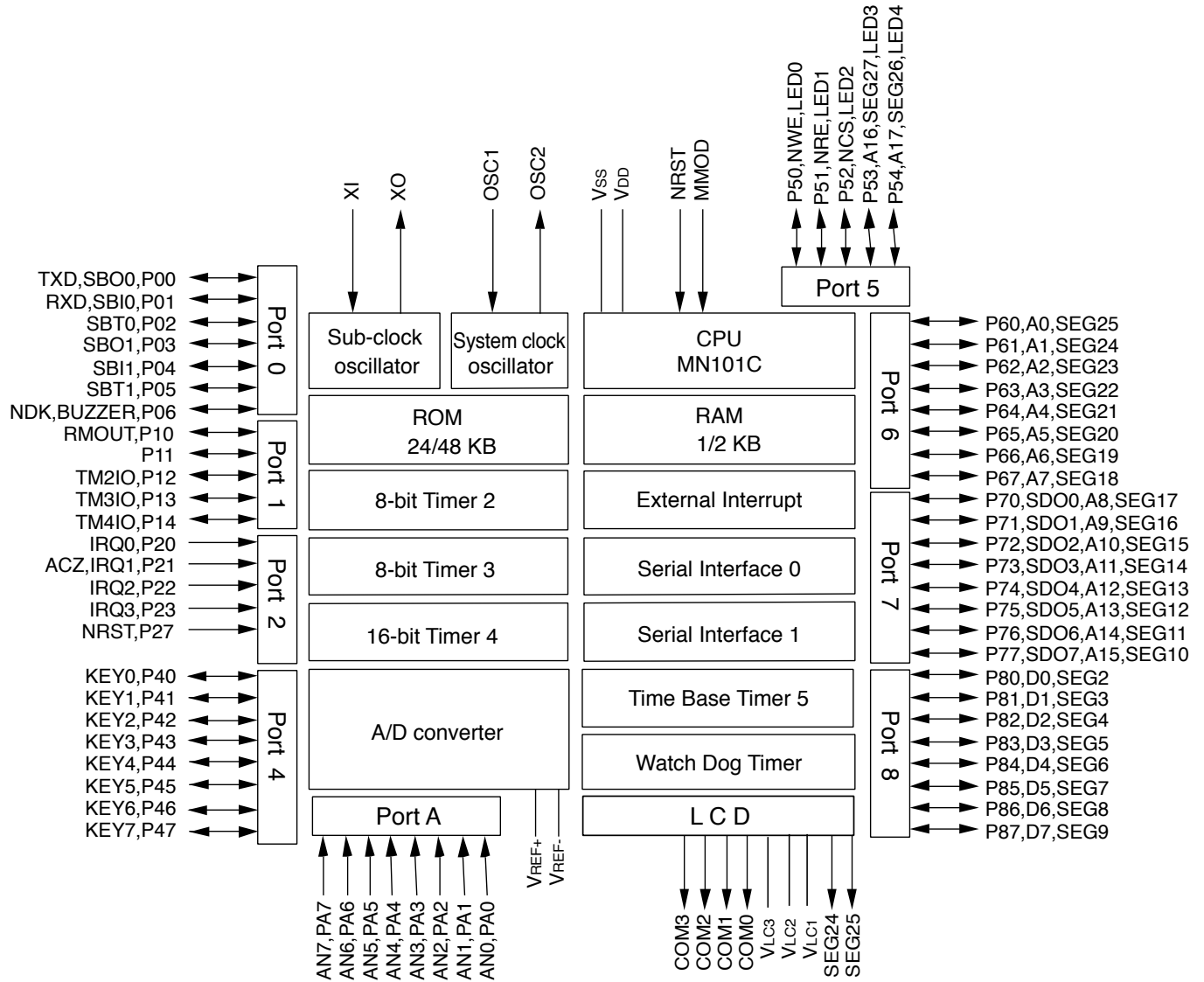

PIN DESCRIPTION OF MN101C39C-399

Pin Specification (1/2)

| Pins | Special Functions | I/O | Direction Control | Pin Control | Functions Description |
|------|-------------------|--------|-------------------|-------------|--|
| P00 | SBO0 TXD | in/out | P0DIR0 | P0PLU0 | SBO0 : Serial Interface 0 transmission data output TXD : UART transmission data output |
| P01 | SBI0 RXD | in/out | P0DIR1 | P0PLU1 | SBI0 : Serial Interface 0 reception data input RXD : UART reception data input |
| P02 | SBT0 | in/out | P0DIR2 | P0PLU2 | SBT0 : Serial Interface 0 clock I/O |
| P03 | SBO1 | in/out | P0DIR3 | P0PLU3 | SBO1 : Serial Interface 1 transmission data output |
| P04 | SBI1 | in/out | P0DIR4 | P0PLU4 | SBI1 : Serial Interface 1 reception data input |
| P05 | SBT1 | in/out | P0DIR5 | P0PLU5 | SBT1 : Serial Interface 1 clock I/O |
| P06 | NDK BUZZER | in/out | P0DIR6 | P0PLU6 | NDK : Data acknowledgement signal BUZZER : Buzzer output |
| P10 | RMOUT | in/out | P1DIR0 | P1PLU0 | RMOUT : Remote control carrier output |
| P11 | | in/out | P1DIR1 | P1PLU1 | |
| P12 | TM2IO | in/out | P1DIR2 | P1PLU2 | TM2IO : Timer 2 I/O |
| P13 | TM3IO | in/out | P1DIR3 | P1PLU3 | TM3IO : Timer 3 I/O |
| P14 | TM4IO | in/out | P1DIR4 | P1PLU4 | TM4IO : Timer 4 I/O |
| P20 | IRQ0 | in | - | P2PLU0 | IRQ0 : External interrupt 0 |
| P21 | IRQ1 ACZ | in | - | P2PLU1 | IRQ1 : External interrupt 1 ACZ : Zero-cross input |
| P22 | IRQ2 | in | - | P2PLU2 | IRQ2 : External interrupt 2 |
| P23 | IRQ3 | in | - | P2PLU3 | IRQ3 : External interrupt 3 |
| P27 | NRST | in | - | - | NRST : Reset |
| P40 | KEY 0 | in/out | P4DIR0 | P4PLU0 | KEY0 : KEY interrupt input 0 |
| P41 | KEY 1 | in/out | P4DIR1 | P4PLU1 | KEY1 : KEY interrupt input 1 |
| P42 | KEY 2 | in/out | P4DIR2 | P4PLU2 | KEY2 : KEY interrupt input 2 |
| P43 | KEY 3 | in/out | P4DIR3 | P4PLU3 | KEY3 : KEY interrupt input 3 |
| P44 | KEY 4 | in/out | P4DIR4 | P4PLU4 | KEY4 : KEY interrupt input 4 |
| P45 | KEY 5 | in/out | P4DIR5 | P4PLU5 | KEY5 : KEY interrupt input 5 |
| P46 | KEY 6 | in/out | P4DIR6 | P4PLU6 | KEY6 : KEY interrupt input 6 |
| P47 | KEY 7 | in/out | P4DIR7 | P4PLU7 | KEY7 : KEY interrupt input 7 |
| P50 | NWE LED0 | in/out | P5DIR0 | P5PLU0 | NWE : Write enable signal LED0 : LED driving pin 0 |
| P51 | NRE LED1 | in/out | P5DIR1 | P5PLU1 | NRE : Read enable signal LED1 : LED driving pin 1 |
| P52 | NCS LED2 | in/out | P5DIR2 | P5PLU2 | NCS : Chip select signal LED2 : LED driving pin 2 |
| P53 | A16 LED3 | in/out | P5DIR3 | P5PLU3 | A16 : Address output (bp16) LED3 : LED driving pin 3 |
| P54 | SEG27 LED4 | in/out | P5DIR4 | P5PLU4 | SEG27 : LCD segment output 27 LED : LED driving pin 4 |
| | SEG26 | | | | SEG26 : LCD segment output 26 |
| P60 | A0 SEG25 | in/out | P6DIR0 | P6PLU0 | A0 : Address output (bp0) SEG25 : LCD segment output 25 |
| P61 | A1 SEG24 | in/out | P6DIR1 | P6PLU1 | A1 : Address output (bp1) SEG24 : LCD segment output 24 |
| P62 | A2 SEG23 | in/out | P6DIR2 | P6PLU2 | A2 : Address output (bp2) SEG23 : LCD segment output 23 |
| P63 | A3 SEG22 | in/out | P6DIR3 | P6PLU3 | A3 : Address output (bp3) SEG22 : LCD segment output 22 |
| P64 | A4 SEG21 | in/out | P6DIR4 | P6PLU4 | A4 : Address output (bp4) SEG21 : LCD segment output 21 |
| P65 | A5 SEG20 | in/out | P6DIR5 | P6PLU5 | A5 : Address output (bp5) SEG20 : LCD segment output 20 |
| P66 | A6 SEG19 | in/out | P6DIR6 | P6PLU6 | A6 : Address output (bp6) SEG19 : LCD segment output 19 |
| P67 | A7 SEG18 | in/out | P6DIR7 | P6PLU7 | A7 : Address output (bp7) SEG18 : LCD segment output 18 |

Pin Specification (2/2)

| Pins | Special Functions | I/O | Direction Control | Pin Control | Functions Description |
|------|-------------------|--------|-------------------|-------------|--|
| P70 | A8 SEG17 SDO0 | in/out | P7DIR0 | P7PLUD0 | A8 : Address output (bp8) SEG17 : LCD segment output 17 SDO0 : Synchronous output 0 |
| P71 | A9 SEG16 SDO1 | in/out | P7DIR1 | P7PLUD1 | A9 : Address output (bp9) SEG16 : LCD segment output 16 SDO1 : Synchronous output 1 |
| P72 | A10 SEG15 SDO2 | in/out | P7DIR2 | P7PLUD2 | A10 : Address output (bp10) SEG15 : LCD segment output 15 SDO2 : Synchronous output 2 |
| P73 | A11 SEG14 SDO3 | in/out | P7DIR3 | P7PLUD3 | A11 : Address output (bp11) SEG14 : LCD segment output 14 SDO3 : Synchronous output 3 |
| P74 | A12 SEG13 SDO4 | in/out | P7DIR4 | P7PLUD4 | A12 : Address output (bp12) SEG13 : LCD segment output 13 SDO4 : Synchronous output 4 |
| P75 | A13 SEG12 SDO5 | in/out | P7DIR5 | P7PLUD5 | A13 : Address output (bp13) SEG12 : LCD segment output 12 SDO5 : Synchronous output 5 |
| P76 | A14 SEG11 SDO6 | in/out | P7DIR6 | P7PLUD6 | A14 : Address output (bp14) SEG11 : LCD segment output 11 SDO6 : Synchronous output 6 |
| P77 | A15 SEG10 SDO7 | in/out | P7DIR7 | P7PLUD7 | A15 : Address output (bp15) SEG10 : LCD segment output 10 SDO7 : Synchronous output 7 |
| P80 | D0 SEG2 | in/out | P8DIR0 | P8PLU0 | D0 : Data I/O (bp0) SEG2 : LCD segment output 2 |
| P81 | D1 SEG3 | in/out | P8DIR1 | P8PLU1 | D1 : Data I/O (bp1) SEG3 : LCD segment output 3 |
| P82 | D2 SEG4 | in/out | P8DIR2 | P8PLU2 | D2 : Data I/O (bp2) SEG4 : LCD segment output 4 |
| P83 | D3 SEG5 | in/out | P8DIR3 | P8PLU3 | D3 : Data I/O (bp3) SEG5 : LCD segment output 5 |
| P84 | D4 SEG6 | in/out | P8DIR4 | P8PLU4 | D4 : Data I/O (bp4) SEG6 : LCD segment output 6 |
| P85 | D5 SEG7 | in/out | P8DIR5 | P8PLU5 | D5 : Data I/O (bp5) SEG7 : LCD segment output 7 |
| P86 | D6 SEG8 | in/out | P8DIR6 | P8PLU6 | D6 : Data I/O (bp6) SEG8 : LCD segment output 8 |
| P87 | D7 SEG9 | in/out | P8DIR7 | P8PLU7 | D7 : Data I/O (bp7) SEG9 : LCD segment output 9 |
| PA0 | AN0 | in | - | PAPLUD0 | AN0 : Analog 0 input |
| PA1 | AN1 | in | - | PAPLUD1 | AN1 : Analog 1 input |
| PA2 | AN2 | in | - | PAPLUD2 | AN2 : Analog 2 input |
| PA3 | AN3 | in | - | PAPLUD3 | AN3 : Analog 3 input |
| PA4 | AN4 | in | - | PAPLUD4 | AN4 : Analog 4 input |
| PA5 | AN5 | in | - | PAPLUD5 | AN5 : Analog 5 input |
| PA6 | AN6 | in | - | PAPLUD6 | AN6 : Analog 6 input |
| PA7 | AN7 | in | - | PAPLUD7 | AN7 : Analog 7 input |
| SEG0 | SEG0 | out | - | - | SEG0 : LCD segment output 0 |
| SEG1 | SEG1 | out | - | - | SEG1 : LCD segment output 1 |
| COM0 | COM0 | out | - | - | COM0 : LCD common output 0 |
| COM1 | COM1 | out | - | - | COM1 : LCD common output 1 |
| COM2 | COM2 | out | - | - | COM2 : LCD common output 2 |
| COM3 | COM3 | out | - | - | COM3 : LCD common output 3 |

START-UP PROCEDURE -CHART

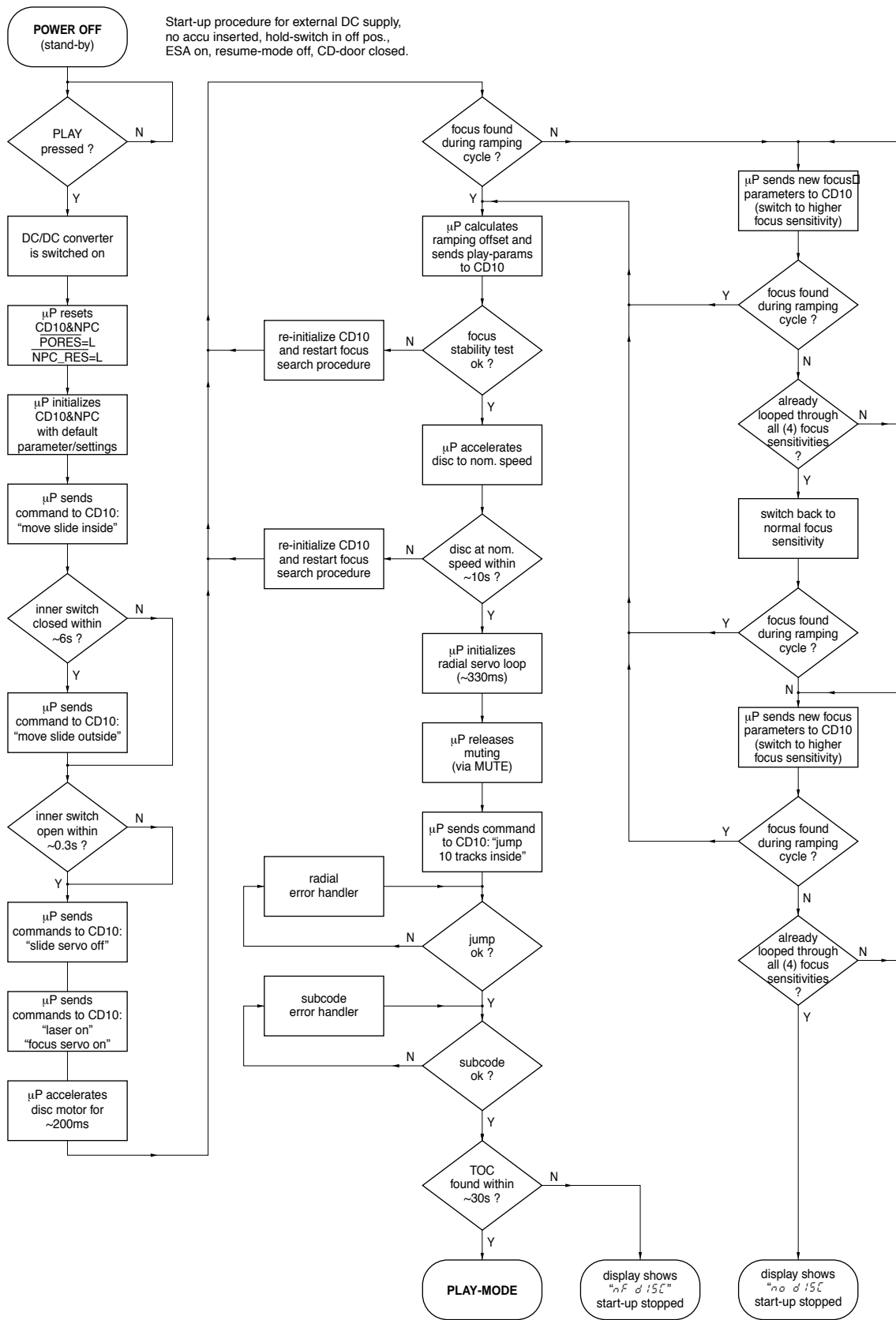

SERVICE TEST PROGRAM

1. PRELIMINARY SETUP

- To enter the service test program disconnect the AC/DC adaptor and remove batteries, open the CD-door and hold the buttons "PLAY" & "VOL+" depressed while turning power on (i.e. connecting the AC/DC adaptor).
- The display shows the software version of the built-in μP (i.e. "5-28"). Versions are counted from "00" onwards; that means the higher the number the newer the software.
- The program is now in the main menu – various tests can be entered by pressing the corresponding buttons (see flow chart on next page or detailed description of available tests below).
- To exit the service test program press the "STOP" button or disconnect the set from the power source.

2. DISPLAY TEST

Purpose: Check functionality of display and display driver.

- To enter the display test start the service test program and press the "NEXT" button.
- The display shows test pattern1. All segments are activated for finding open circuits (see flow chart on next page).
- To jump to the next pattern press the "NEXT" button.
- The display shows test pattern2. All alternate pins (2, 4, ...) are activated for finding short circuits (see flow chart on next page).
- To jump back to test pattern1 press the "NEXT" button, to exit the display test and return to the main menu press the "STOP" button.

3. KEY TEST

Purpose: Check operation of keys and cord remote control.

- To enter the key test start the service test program and press the "MODE" button.
- The display shows "--".
- Hold key depressed and check corresponding key code on the display. Key codes can be found in table1 (see flow chart on next page).
- To exit the key test and return to the main menu press the "STOP" button.

4. PLAYBACK TEST WITH ERROR ANALYSIS

Purpose: Analyze errors that occur during playback and search for intermittent failures.

- To enter the playback test start the service test program and press the "BASS" button.
- To start the error analysis press the "PLAY" button. Note that the playback test can only be entered if the CD-door is closed.
- The set will read the TOC and start playback.

As long as the playback is free of errors the display shows track and time information like in normal play-mode. In case of errors corresponding error codes will be displayed. The meaning of these error codes can be found in table2 (see flow chart on next page).

Note: Errors can either be "fatal" or "non fatal". Fatal errors always stop the playback, non fatal errors only cause a short interruption of the music. Fatal errors are displayed as long as the set is connected to the power source, non fatal errors are displayed until a new error occurs or a button is pressed.

- To stop the playback test disconnect the set from the power source.

5. SERVO TEST

Purpose: Check door switch, inner switch of CD-drive, movement of slide and acceleration of discmotor.

- To enter the servo test start the service test program and press the "PLAY" button.
- The display shows "L d xy".
"x" indicates state of door switch;
"y" indicates state of inner switch.
x,y = "0" means switch is closed; "1" means switch is open.
- To move slide outside hold the "NEXT" button depressed.
- To move slide inside hold the "PREV" button depressed.
- To accelerate the discmotor clockwise hold the "MODE" button depressed.
- To accelerate the discmotor counter-clockwise hold the "PROG" button depressed.
- To enter the focus test press the "PLAY" button, to exit the servo test and return to the main menu press the "STOP" button.

6. FOCUS TEST

Purpose: Check movement of lens and operation of focus servo for CDDA and CDRW discs.

Since the CDRW reflects much less light than an ordinary CDDA, the gain of the HF-amplifier stage and the sensitivity of the ADC inside the Decoder&Digital Servo IC "CD10" must be adapted accordingly. The gain is switched via the CDRW input of the HF-preamplifier. The ADC-sensitivity is set via software parameters (sent from μP to "CD10"). In total, there are 4 sensitivity modes available: 1 for CDDA and 3 for CDRW. The modes are listed in table3 (see next page). In normal play-mode, the correct focus sensitivity is chosen automatically during start-up (see "Start-up procedure" on previous page). In the service test program, the sensitivity can be chosen manually in order to allow individual measurements in several modes.

- The focus servo loop is switched on and the set starts searching the focus ("focus ramping"). As soon as the focus has been found the focus servo loop is closed and the state of the focus is monitored continuously.
- If the focus is OK the display shows " F x", else "- F x".
"x" indicates the sensitivity mode. Details can be found in table3 (see flow chart on next page).
- To toggle between sensitivity modes press the "BASS" button.
- To move slide outside hold the "NEXT" button depressed.
- To move slide inside hold the "PREV" button depressed.
- To accelerate the discmotor clockwise hold the "MODE" button depressed.
- To accelerate the discmotor counter-clockwise hold the "PROG" button depressed.
- In case the focus is OK the discmotor test can be entered by pressing the "PLAY" button, to exit the focus test and return to the main menu press the "STOP" button.

7. DISCMOTOR TEST

Purpose: Check speed regulation of discmotor.

- The speed regulation is switched on and the discmotor starts rotating. If the speed reaches 75% of the nom. speed the display shows " d", else "- d".
- In parallel also the state of the focus is monitored continuously (display " F x" or "- F x").
- In case the disc speed is OK and the focus is OK the radial test can be entered by pressing the "PLAY" button, to exit the discmotor test and return to the main menu press the "STOP" button.

8. RADIAL TEST

Purpose: Check if radial loop locks and an audio signal is audible at the headphone output.

- The radial servo loop is switched on, mute is released and the audio signal is audible. If the system is on track the display shows " r", else "- r".
- In parallel also the disc speed (display " d" or "- d") and the state of the focus (display " F x" or "- F x") are monitored continuously. Note: In case of radial errors the audio output is muted and muting is not released automatically when the systems recovers from the error. "- r" remains on the display.
To open mute again press the "NEXT" or "PREV" button.
- To jump 16 tracks outside press the "NEXT" button.
- To jump 16 tracks inside press the "PREV" button.
- To exit the radial test and return to the main menu press the "STOP" button, to exit the service test program disconnect the set from the power source.

Important remark:

In radial test mode data to the DRAM is written at 1.2 times the nominal speed, and read from the DRAM at nominal speed. Because writing is done faster than reading the DRAM gets full after a certain time.

In normal play mode the system would now wait until the DRAM is partly emptied again, jump backwards and resume filling at the last written position. However, in radial test mode the jumps would disturb measurements on the radial servo loop. Therefore this function has been disabled and filling restarts immediately from the current position of the pick-up unit. As a result "jumps" are audible during playback.

SERVICE TEST PROGRAM - FLOW CHART

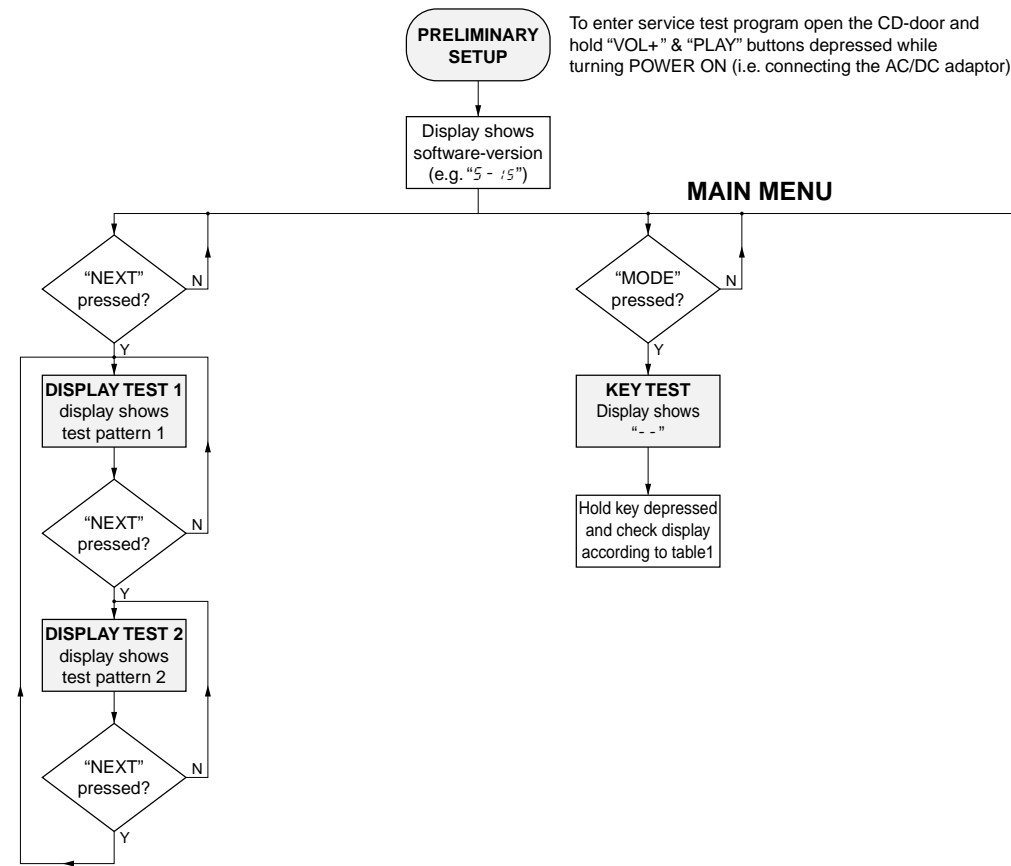

test pattern 1 (all segments activated)

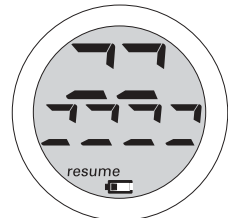

test pattern 2 (alternate segments activated)



table1 - key test

| KEY | DISPLAY |
|----------|---------|
| DBB | 0 1 |
| PROGRAM | 0 2 |
| MODE | 0 3 |
| PLAY | 0 5 |
| NEXT | 0 6 |
| PREVIOUS | 0 7 |

Press "STOP" on the CD-player to exit the key test.

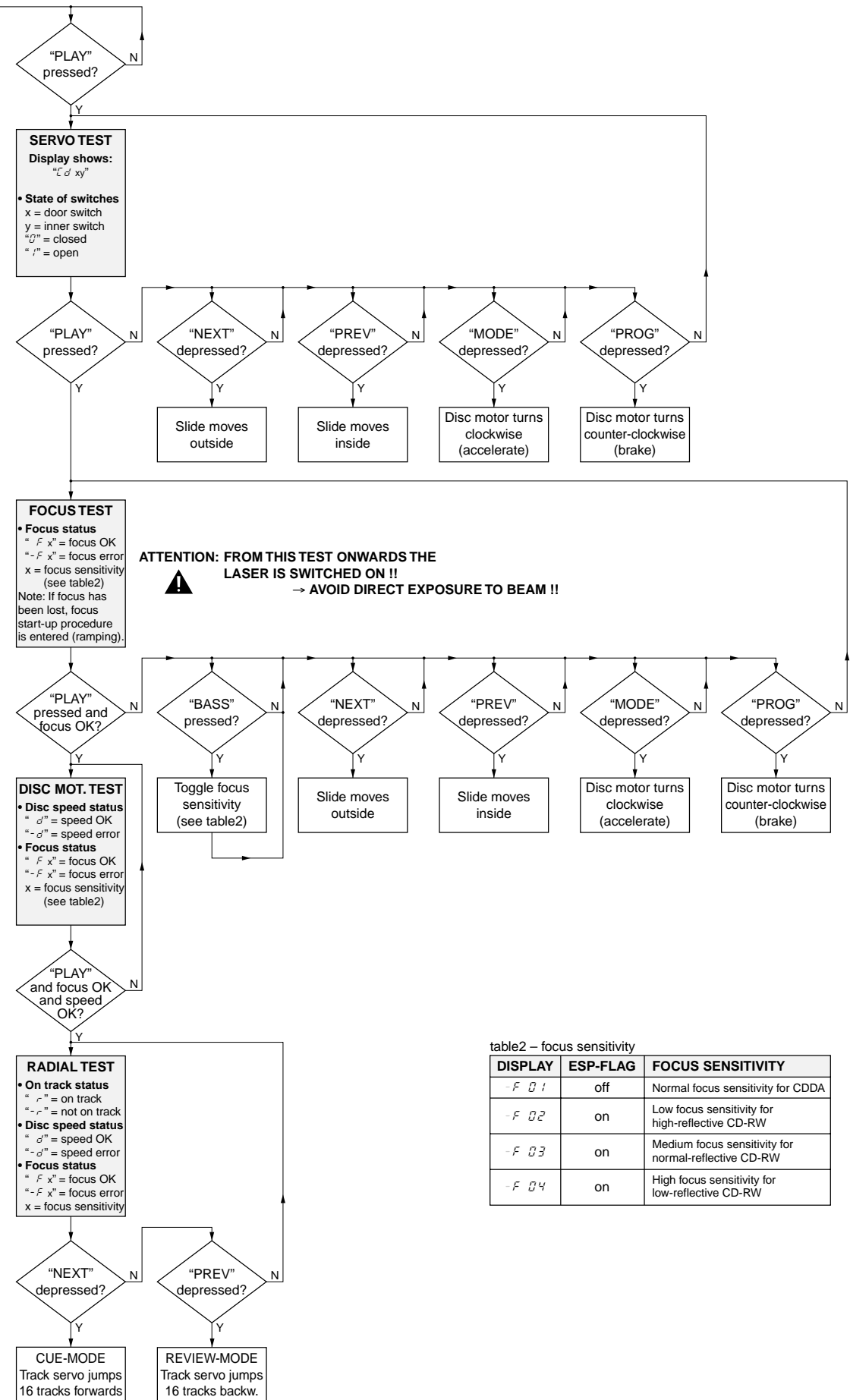

ATTENTION: FROM THIS TEST ONWARDS THE LASER IS SWITCHED ON !!
 → AVOID DIRECT EXPOSURE TO BEAM !!

table2 - focus sensitivity

| DISPLAY | ESP-FLAG | FOCUS SENSITIVITY |
|---------|----------|--|
| - F 0 1 | off | Normal focus sensitivity for CDDA |
| - F 0 2 | on | Low focus sensitivity for high-reflective CD-RW |
| - F 0 3 | on | Medium focus sensitivity for normal-reflective CD-RW |
| - F 0 4 | on | High focus sensitivity for low-reflective CD-RW |

BLOCKDIAGRAM

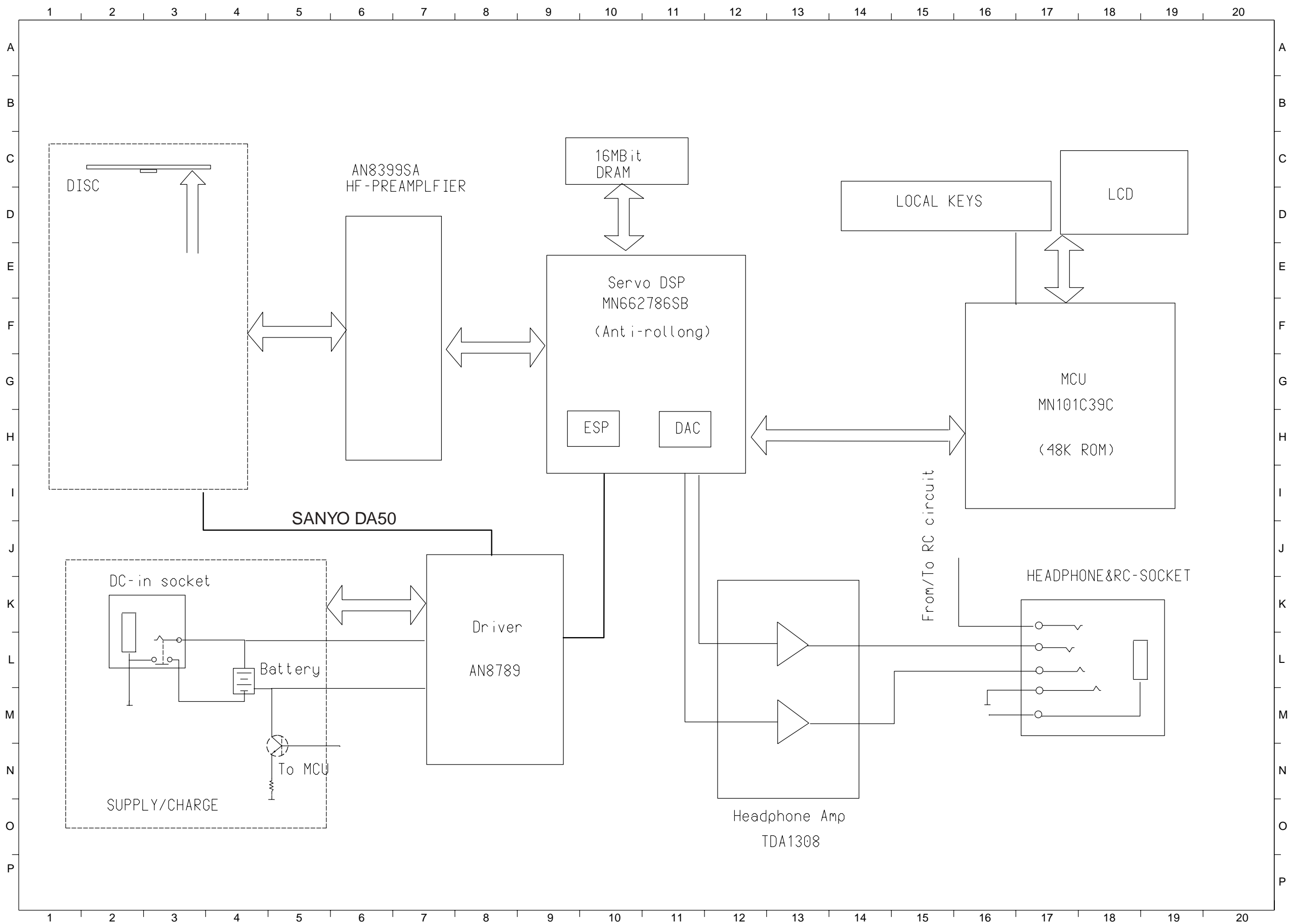

CIRCUIT DIAGRAM - CONTROL / SUPPLY PART

- U4 G2 3439 D14
- U5 F3 3440 D16
- U6 C2 5300 E5
- U7 E3 5301 F5
- U8 C5 5303 G5
- U9 F7 6302 G3
- U10 E7 6304 E3
- U11 F7 6401 D8
- U12 E7 6402 D12
- U13 H2 6403 C15
- U14 H10 6404 F10
- U15 C13 6405 E12
- U16 C13 6406 E11
- U17 C13 6407 E11
- U18 C13 7300 I6
- U19 C13 7301 H2
- U20 C13 7303 H3
- U21 C13 7304 H4
- U22 C13 7306 J3
- U23 C13 7307 J3
- U24 C13 7309 C9
- U25 C14 7310 C9
- U26 C14 7311 D2
- U27 C14 7312 D3
- U28 C14 7313 D3
- U29 C14 7401 C6
- U30 C14 7402 D7
- U31 C14 7403 C12
- U32 C14 7404 C11
- U34 C10 7405 F14
- U35 C14 7406 J13
- U36 C14 7407 C7
- U37 C14 7408 G3
- U50 E7 U163 F16
- U54 E9 U164 F16
- U58 G7 U165 H16
- U61 D5 U168 G16
- U65 F2 U167 G16
- U68 F2 U168 G12
- U69 G11 U169 G11
- U70 H11 U180 H11
- U71 H11 U182 H16

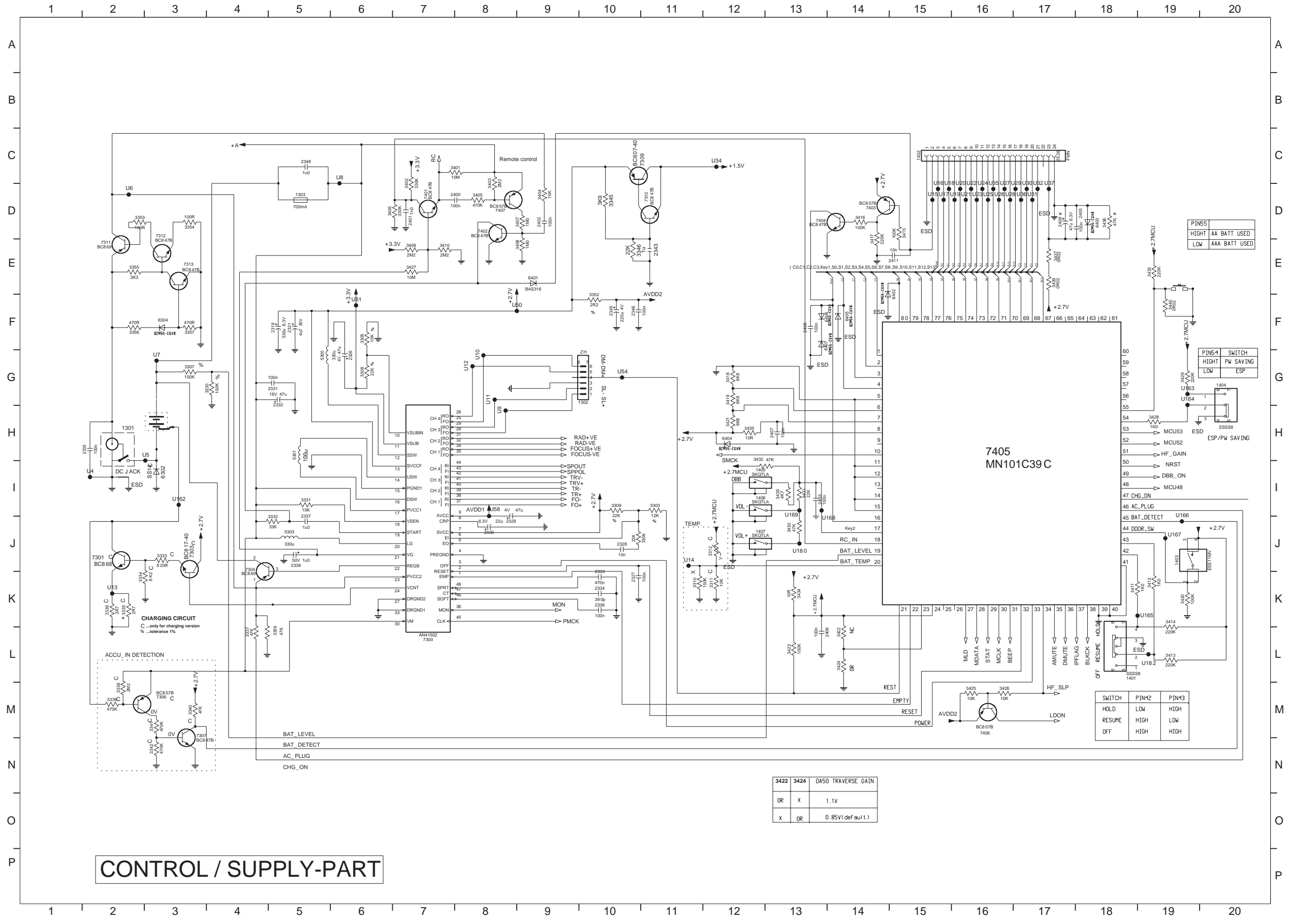

CONTROL / SUPPLY-PART

| | 3422 | 3424 | DA50 TRAVERSE GAIN |
|----|------|------|--------------------|
| OR | X | | 1.1V |
| X | OR | | 0.85V (default) |

| PIN5 | |
|-------|---------------|
| HIGHT | AA BATT USED |
| LOW | AAA BATT USED |

| PIN54 | SWITCH |
|-------|-----------|
| HIGHT | PW SAVING |
| LOW | ESP |

| SWITCH | PIN42 | PIN43 |
|--------|-------|-------|
| HOLD | LOW | HIGH |
| RESUME | HIGH | LOW |
| OFF | HIGH | HIGH |

CIRCUIT DIAGRAM - AUDIO PART

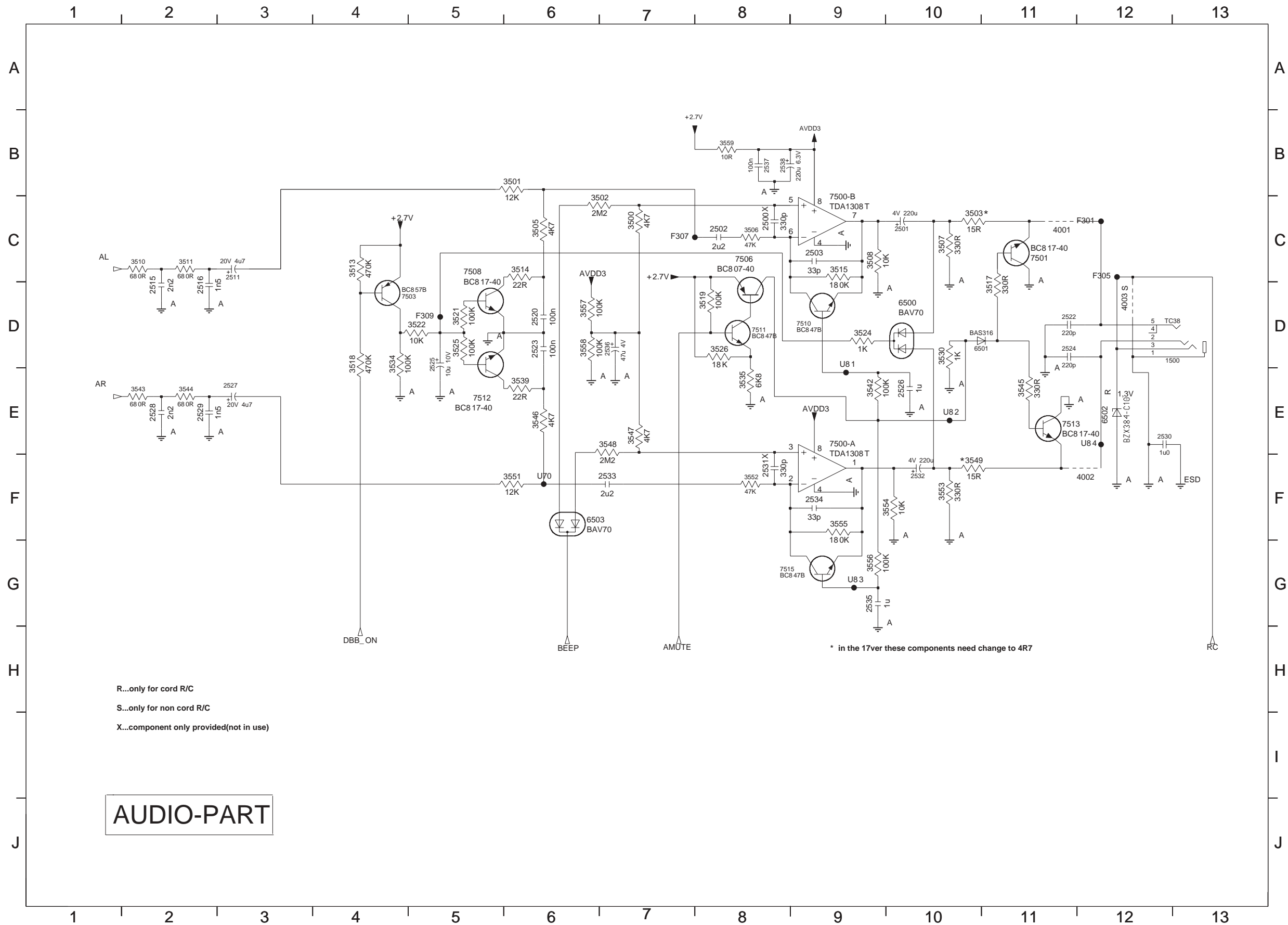

- U70 E6
- U81 D8
- U82 D9
- U83 F9
- U84 D11
- 1500 D11
- 2500 B8
- 2501 B9
- 2502 B7
- 2503 C8
- 2511 C3
- 2515 C2
- 2516 C3
- 2520 C6
- 2522 C10
- 2523 C6
- 2524 C10
- 2525 D5
- 2526 D9
- 2527 D3
- 2528 D2
- 2529 D3
- 2530 D11
- 2531 E8
- 2532 E9
- 2533 E6
- 2534 E8
- 2535 F9
- 2536 C6
- 2537 B8
- 2538 B8
- 3500 B7
- 3501 B5
- 3502 B6
- 3503 B10
- 3505 B6
- 3506 B8
- 3507 C9
- 3508 C9
- 3510 C2
- 3511 C3
- 3513 C4
- 3514 C6
- 3515 C8
- 3517 C10
- 3518 D4
- 3519 C7
- 3521 C5
- 3522 C5
- 3524 C9
- 3525 C5
- 3526 C7
- 3530 D9
- 3534 D4
- 3535 D8
- 3539 D6
- 3542 D9
- 3543 D2
- 3544 D3
- 3545 D10
- 3546 D6
- 3547 D7
- 3548 D6
- 3549 D10
- 3551 E5
- 3552 E8
- 3553 E9
- 3554 E9
- 3555 E8
- 3556 E9
- 3557 C6
- 3558 C6
- 3559 B7
- 4001 B10
- 4002 E11
- 4003 C11
- 6500 C9
- 6501 C10
- 6502 D11
- 6503 E6
- 7500-A D8
- 7500-B B8
- 7501 C10
- 7503 C4
- 7506 C8
- 7508 C5
- 7510 C8
- 7511 C8
- 7512 D5
- 7513 D10
- 7515 E8
- F301 B11
- F305 C11
- F307 B7
- F309 C5

R...only for cord R/C
 S...only for non cord R/C
 X...component only provided(not in use)

AUDIO-PART

CIRCUIT DIAGRAM - CD PART

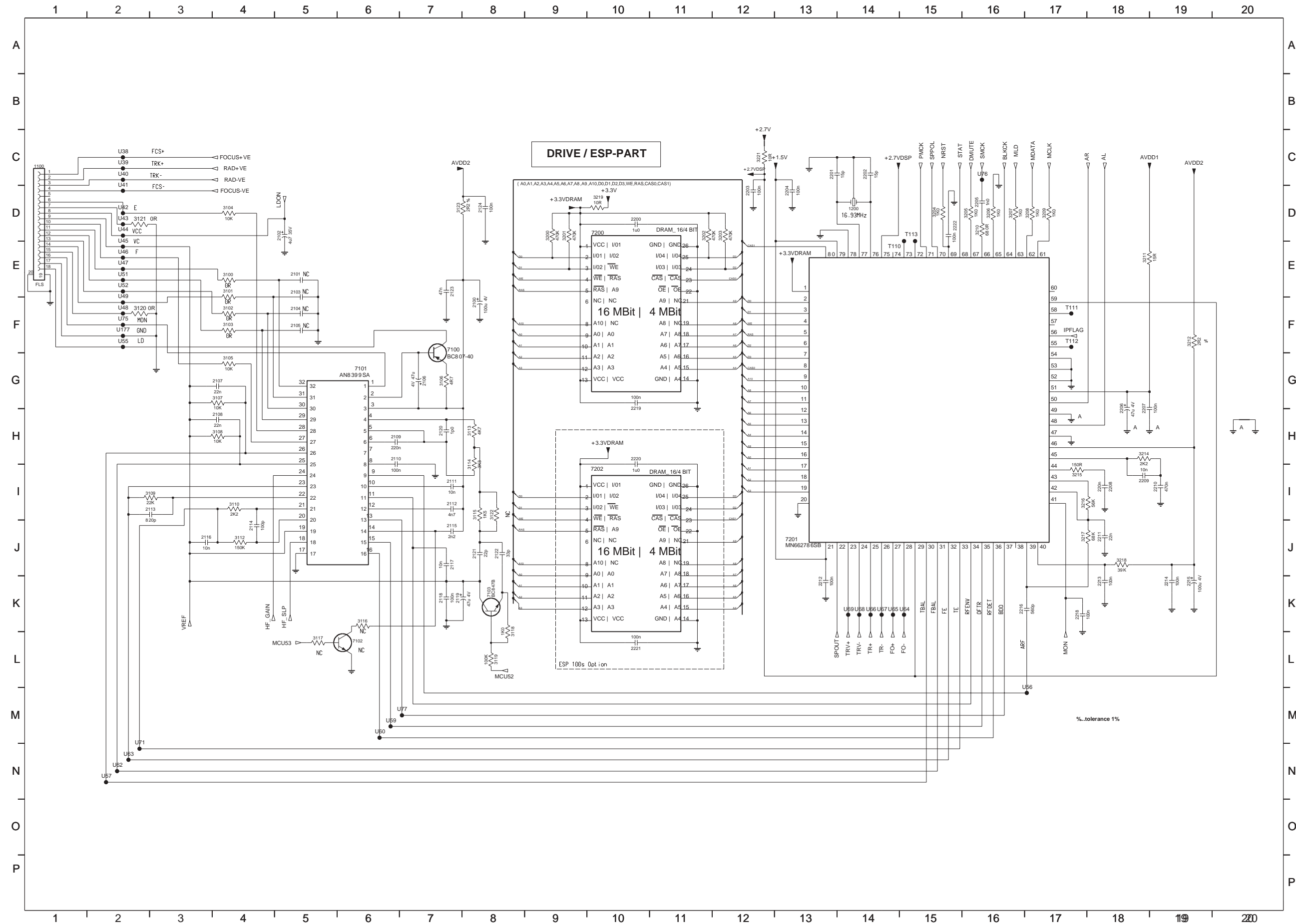

- U38 C2
- U39 C2
- U40 C2
- U41 C2
- U42 C2
- U43 C2
- U44 D2
- U45 D2
- U46 D2
- U47 D2
- U48 E2
- U49 D2
- U51 D2
- U52 D2
- U55 E2
- U56 I14
- U57 K2
- U59 J6
- U60 J6
- U62 J2
- U63 J2
- U64 H12
- U65 H12
- U66 H12
- U67 H12
- U68 H12
- U69 H12
- U71 J3
- U75 E2
- U76 C13
- U77 J6
- 1100 C1
- 1200 C12
- 2100 D7
- 2101 D5
- 2102 D4
- 2103 D5
- 2104 D5
- 2105 E5
- 2106 E6
- 2107 E4
- 2108 F4
- 2109 G6
- 2110 F6
- 2111 G7
- 2112 G7
- 2113 G3
- 2114 G4
- 2115 G7
- 2116 G3
- 2117 H7
- 2118 H6
- 2119 H7
- 2120 F6
- 2121 H7
- 2122 H7
- 2123 D7
- 2124 C7
- 2200 C9
- 2201 C11
- 2202 C12
- 2203 C10
- 2204 C11
- 2205 C13
- 2206 F15
- 2207 F15
- 2208 G15
- 2209 G15
- 2210 G16
- 2211 G15
- 2212 H11
- 2213 H15
- 2214 H16
- 2215 H16
- 2216 H14
- 2218 H15
- 2219 F9
- 2220 F9
- 2221 I9
- 2222 C13
- 3100 D4
- 3101 D4
- 3102 E4
- 3103 E4
- 3104 C4
- 3105 E4
- 3106 E6
- 3107 F4
- 3108 F4
- 3109 G3
- 3110 G4
- 3112 G4
- 3113 F7
- 3114 F7
- 3115 G7
- 3116 I5
- 3117 I5
- 3118 I7
- 3119 I7
- 3120 E3
- 3121 C3
- 3122 G7
- 3123 C7
- 3200 D8
- 3201 D8
- 3202 D10
- 3203 D10
- 3204 C13
- 3205 C13
- 3206 C13
- 3207 C14
- 3208 C14
- 3209 C14
- 3210 C13
- 3211 D15
- 3212 E16
- 3214 F15
- 3215 G15
- 3216 G15
- 3217 G15
- 3218 H15
- 3219 C8
- 3221 C10
- 7100 E6
- 7101 E5
- 7102 I5
- 7103 H7
- 7200 D8
- 7201 G11
- 7202 G8
- T110 D12
- T111 E14
- T112 E14
- T113 D12
- U177 E2

LAYOUT DIAGRAM - Copper Side

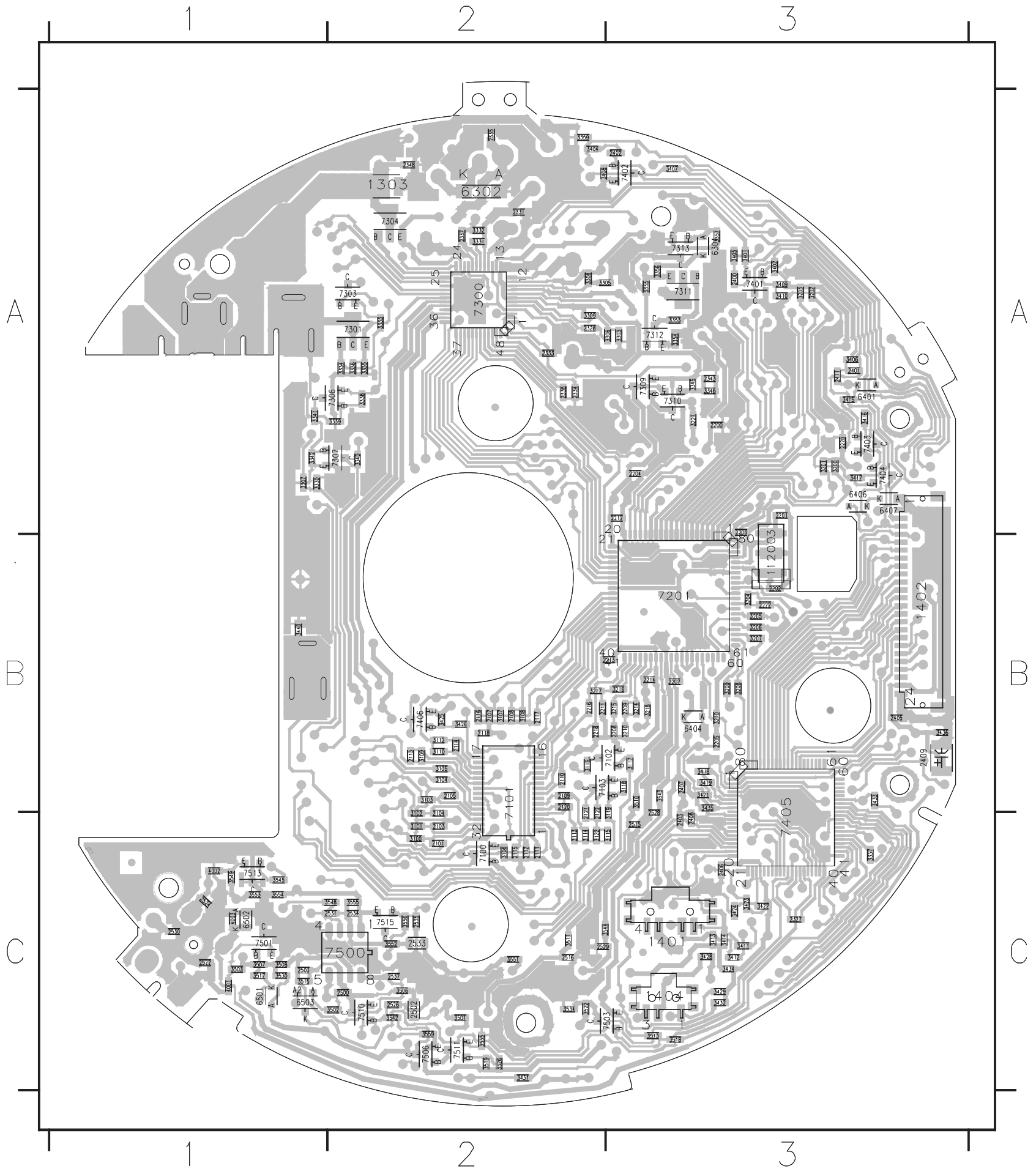

| | | | | | |
|----|----|-----|---|---|---|
| 1 | 2 | 3 | A | B | C |
| 2 | 3 | 4 | A | B | C |
| 3 | 4 | 5 | A | B | C |
| 4 | 5 | 6 | A | B | C |
| 5 | 6 | 7 | A | B | C |
| 6 | 7 | 8 | A | B | C |
| 7 | 8 | 9 | A | B | C |
| 8 | 9 | 10 | A | B | C |
| 9 | 10 | 11 | A | B | C |
| 10 | 11 | 12 | A | B | C |
| 11 | 12 | 13 | A | B | C |
| 12 | 13 | 14 | A | B | C |
| 13 | 14 | 15 | A | B | C |
| 14 | 15 | 16 | A | B | C |
| 15 | 16 | 17 | A | B | C |
| 16 | 17 | 18 | A | B | C |
| 17 | 18 | 19 | A | B | C |
| 18 | 19 | 20 | A | B | C |
| 19 | 20 | 21 | A | B | C |
| 20 | 21 | 22 | A | B | C |
| 21 | 22 | 23 | A | B | C |
| 22 | 23 | 24 | A | B | C |
| 23 | 24 | 25 | A | B | C |
| 24 | 25 | 26 | A | B | C |
| 25 | 26 | 27 | A | B | C |
| 26 | 27 | 28 | A | B | C |
| 27 | 28 | 29 | A | B | C |
| 28 | 29 | 30 | A | B | C |
| 29 | 30 | 31 | A | B | C |
| 30 | 31 | 32 | A | B | C |
| 31 | 32 | 33 | A | B | C |
| 32 | 33 | 34 | A | B | C |
| 33 | 34 | 35 | A | B | C |
| 34 | 35 | 36 | A | B | C |
| 35 | 36 | 37 | A | B | C |
| 36 | 37 | 38 | A | B | C |
| 37 | 38 | 39 | A | B | C |
| 38 | 39 | 40 | A | B | C |
| 39 | 40 | 41 | A | B | C |
| 40 | 41 | 42 | A | B | C |
| 41 | 42 | 43 | A | B | C |
| 42 | 43 | 44 | A | B | C |
| 43 | 44 | 45 | A | B | C |
| 44 | 45 | 46 | A | B | C |
| 45 | 46 | 47 | A | B | C |
| 46 | 47 | 48 | A | B | C |
| 47 | 48 | 49 | A | B | C |
| 48 | 49 | 50 | A | B | C |
| 49 | 50 | 51 | A | B | C |
| 50 | 51 | 52 | A | B | C |
| 51 | 52 | 53 | A | B | C |
| 52 | 53 | 54 | A | B | C |
| 53 | 54 | 55 | A | B | C |
| 54 | 55 | 56 | A | B | C |
| 55 | 56 | 57 | A | B | C |
| 56 | 57 | 58 | A | B | C |
| 57 | 58 | 59 | A | B | C |
| 58 | 59 | 60 | A | B | C |
| 59 | 60 | 61 | A | B | C |
| 60 | 61 | 62 | A | B | C |
| 61 | 62 | 63 | A | B | C |
| 62 | 63 | 64 | A | B | C |
| 63 | 64 | 65 | A | B | C |
| 64 | 65 | 66 | A | B | C |
| 65 | 66 | 67 | A | B | C |
| 66 | 67 | 68 | A | B | C |
| 67 | 68 | 69 | A | B | C |
| 68 | 69 | 70 | A | B | C |
| 69 | 70 | 71 | A | B | C |
| 70 | 71 | 72 | A | B | C |
| 71 | 72 | 73 | A | B | C |
| 72 | 73 | 74 | A | B | C |
| 73 | 74 | 75 | A | B | C |
| 74 | 75 | 76 | A | B | C |
| 75 | 76 | 77 | A | B | C |
| 76 | 77 | 78 | A | B | C |
| 77 | 78 | 79 | A | B | C |
| 78 | 79 | 80 | A | B | C |
| 79 | 80 | 81 | A | B | C |
| 80 | 81 | 82 | A | B | C |
| 81 | 82 | 83 | A | B | C |
| 82 | 83 | 84 | A | B | C |
| 83 | 84 | 85 | A | B | C |
| 84 | 85 | 86 | A | B | C |
| 85 | 86 | 87 | A | B | C |
| 86 | 87 | 88 | A | B | C |
| 87 | 88 | 89 | A | B | C |
| 88 | 89 | 90 | A | B | C |
| 89 | 90 | 91 | A | B | C |
| 90 | 91 | 92 | A | B | C |
| 91 | 92 | 93 | A | B | C |
| 92 | 93 | 94 | A | B | C |
| 93 | 94 | 95 | A | B | C |
| 94 | 95 | 96 | A | B | C |
| 95 | 96 | 97 | A | B | C |
| 96 | 97 | 98 | A | B | C |
| 97 | 98 | 99 | A | B | C |
| 98 | 99 | 100 | A | B | C |

EXPLODED VIEW DIAGRAM

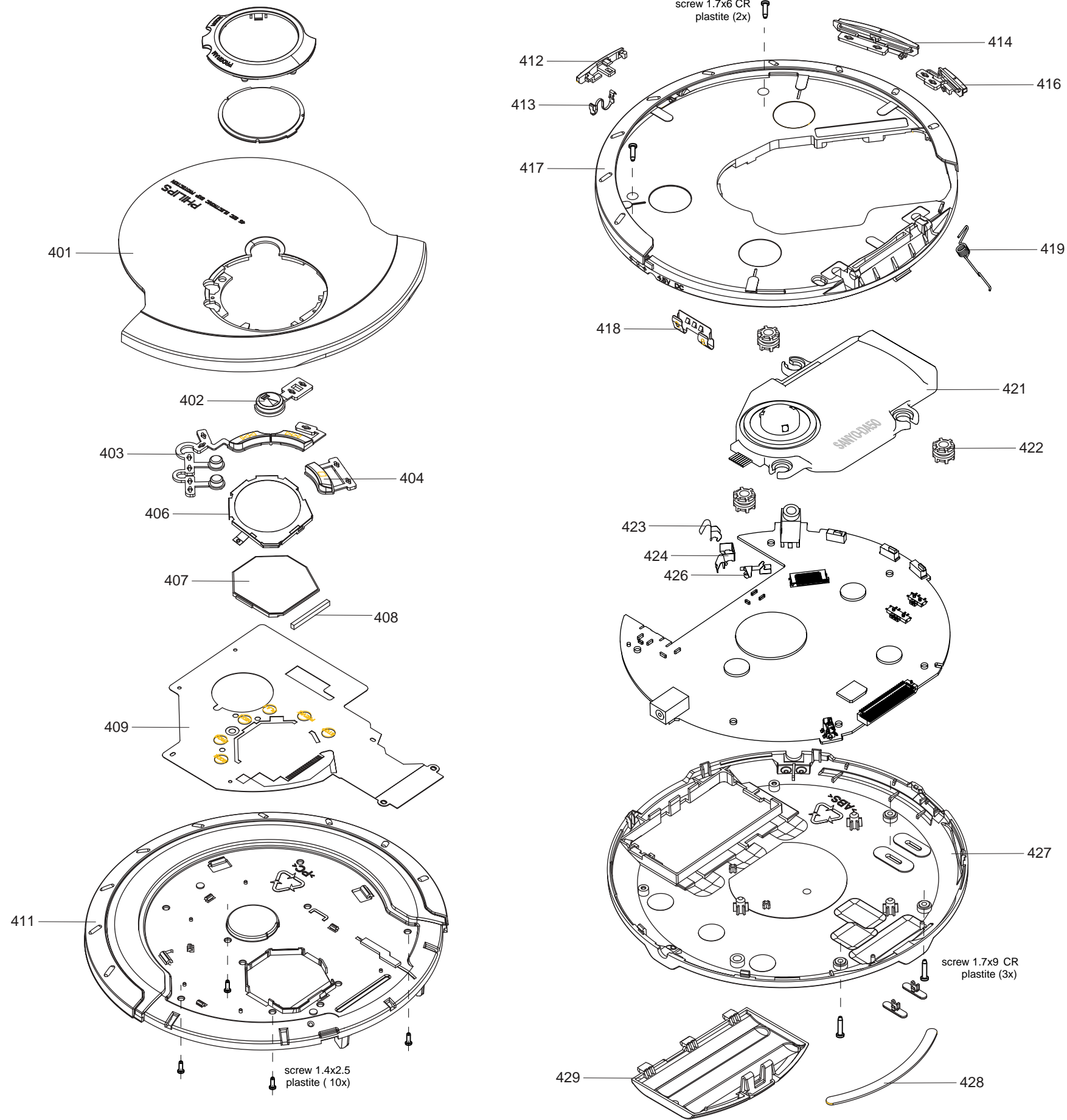

MECHANICAL PARTSLIST - CABINET

| | | |
|-----|-----------------|----------------------------------|
| 401 | 3140 117 67260 | PANEL-ASSY-1 (red) |
| 401 | 3140 117 64340 | PANEL-ASSY-1 (grey) |
| 401 | 3140 117 669 30 | PANEL-ASSY-1 (blue) |
| 402 | 3140 117 67310 | KEY-PLAY |
| 402 | 3140 117 669 80 | KEY-PLAY (only for blue) |
| 403 | 3140 117 64390 | CD KEYSSET |
| 404 | 3140 117 66480 | CDKEY-STOP |
| 406 | 3140 111 22560 | FRAME-LCD |
| 407 | 3140 110 51740 | LCD |
| 408 | 3140 11447480 | ZEBRASTRIP |
| 409 | 3140 11333150 | MEMBRANE KEYBOARD |
| 411 | 3140 117 67250 | DOOR-CD-ASSY-1 (red) |
| 411 | 3140 117 64330 | DOOR-CD-ASSY-1 (grey) |
| 411 | 3140 117 669 20 | DOOR-CD-ASSY-1 (blue) |
| 412 | 3140 117 669 90 | SLIDER-DOOR-OPEN |
| 412 | 3140 117 64410 | SLIDER-DOOR-OPEN (only for grey) |
| 413 | 3140 111 22610 | SPRING-SLIDER-OPEN |
| 414 | 3140 117 67000 | KNOB-VOLUME |
| 414 | 3140 117 64420 | KNOB-VOLUME (only for grey) |
| 416 | 3140 117 67010 | KNOB-DBB |
| 416 | 3140 117 64430 | KNOB-DBB (only for grey) |
| 417 | 3140 117 669 40 | CABINET-ASSY-1 |
| 417 | 3140 117 64350 | CABINET-ASSY-1 (only for grey) |
| 418 | 3140 111 22620 | SPRING-BATTERY-SET, +/- |
| 419 | 3140 111 22640 | SPRING-DOOR-OPEN |
| 421 | 2422 549 45374 | CD DRIVE DA50 |
| 422 | 3140 114 47580 | DAMPER-AX5203 |
| 423 | 3140 111 22580 | SPRING BATTERY, -VE |
| 424 | 3140 111 22570 | SPRING BATTERY, +VE |
| 426 | 3140 111 22600 | SPRING BATTERY CHARGE |
| 427 | 3140 117 67350 | BOTTOM-ASSY-1 |
| 427 | 3140 117 64360 | BOTTOM-ASSY-1 (only for grey) |
| 428 | 3140 11449 360 | RUBBER-FOOT |
| 429 | 3140 117669 10 | DOOR-BATTERY-2A |
| 429 | 3140 11766470 | DOOR-BATTERY-2A (only for grey) |

Note: Only these parts mentioned in the list are normal service parts.

ELECTRICAL PARTSLIST - COMBI BOARD**- MISCELLANEOUS -**

| | | |
|------|----------------|---------------------|
| 1100 | 2422 025 17486 | SOCKET FFC 18P |
| 1200 | 4822 242 81865 | CST16,93MXW0C3-TF01 |
| 1301 | 2422 026 05086 | CONNECTOR H 1P |
| 1303 | 2422 086 11012 | FUSE 0,7A 50V |
| 1401 | 2422 127 00547 | SWITCH-SLID 1P |
| 1402 | 4822 265 11248 | CONNECTOR 24P |
| 1403 | 2422 129 16818 | SWITCH-DET 1P |
| 1404 | 2422 127 00543 | SWITCH-SLID 1P |
| 1405 | 2422 128 02968 | SWITCH-TACT 1P |
| 1406 | 2422 128 02968 | SWITCH-TACT 1P |
| 1407 | 2422 128 02968 | SWITCH-TACT 1P |
| 1500 | 2422 026 05401 | SOCKET PHONE H 1P |

- CAPACITORS -

| | | |
|------|----------------|-----------------------|
| 2100 | 4822 124 12108 | 100µF 20% 4V |
| 2102 | 3198 030 74780 | 4,7µF 20% 35V |
| 2106 | 4822 124 81058 | 47µF 20% 4V |
| 2107 | 4822 126 14494 | 22nF 10% X7R 25V |
| 2108 | 4822 126 14494 | 22nF 10% X7R 25V |
| 2109 | 4822 126 13879 | 220nF +80-20% 16V |
| 2110 | 2238 586 59812 | 100nF +80-20% Y5V 50V |
| 2111 | 5322 126 11583 | 10nF 10% X7R 50V |
| 2112 | 4822 126 13193 | 4,7nF 10% X7R 63V |
| 2113 | 3198 016 38210 | 820pF NP0 25V |
| 2114 | 2020 552 94427 | 100pF 5% NP0 50V |
| 2115 | 4822 126 14238 | 2,2nF X7R 50V |
| 2116 | 5322 126 11583 | 10nF 10% X7R 50V |
| 2117 | 5322 126 11583 | 10nF 10% X7R 50V |
| 2118 | 2238 586 59812 | 100nF +80-20% Y5V 50V |
| 2119 | 4822 124 81058 | 47µF 20% 4V |
| 2121 | 4822 122 33761 | 22pF 5% NP0 50V |
| 2122 | 2222 867 15339 | 33pF 5% NP0 50V |
| 2123 | 3198 024 44730 | 47nF Y5V 50V |
| 2124 | 2238 586 59812 | 100nF +80-20% Y5V 50V |
| 2200 | 3198 017 41050 | 1µF Y5V 10V |
| 2201 | 4822 122 33752 | 15pF 5% NP0 50V |
| 2202 | 4822 122 33752 | 15pF 5% NP0 50V |
| 2203 | 2238 586 59812 | 100nF +80-20% Y5V 50V |
| 2204 | 2238 586 59812 | 100nF +80-20% Y5V 50V |
| 2205 | 5322 126 11578 | 1nF 10% X7R 50V |
| 2206 | 4822 124 81058 | 47µF 20% 4V |
| 2207 | 2238 586 59812 | 100nF +80-20% Y5V 50V |
| 2208 | 4822 126 13879 | 220nF +80-20% 16V |
| 2209 | 5322 126 11583 | 10nF 10% X7R 50V |
| 2210 | 3198 017 44740 | 470nF Y5V 10V |
| 2211 | 4822 126 14494 | 22nF 10% X7R 25V |
| 2212 | 2238 586 59812 | 100nF +80-20% Y5V 50V |
| 2213 | 2238 586 59812 | 100nF +80-20% Y5V 50V |
| 2214 | 2238 586 59812 | 100nF +80-20% Y5V 50V |

- CAPACITORS -

| | | |
|------|----------------|-----------------------|
| 2215 | 4822 124 12108 | 100µF 20% 4V |
| 2216 | 4822 126 14249 | 560pF 10% X7R 50V |
| 2218 | 2238 586 59812 | 100nF +80-20% Y5V 50V |
| 2219 | 2238 586 59812 | 100nF +80-20% Y5V 50V |
| 2220 | 3198 017 41050 | 1µF Y5V 10V |
| 2221 | 2238 586 59812 | 100nF +80-20% Y5V 50V |
| 2222 | 2238 586 59812 | 100nF +80-20% Y5V 50V |
| 2319 | 2022 029 00632 | 330µF 20% 6,3V |
| 2321 | 3198 030 74780 | 4,7µF 20% 35V |
| 2326 | 4822 124 81058 | 47µF 20% 4V |
| 2327 | 2238 586 59812 | 100nF +80-20% Y5V 50V |
| 2328 | 5322 126 11583 | 10nF 10% X7R 50V |
| 2329 | 4822 124 81058 | 47µF 20% 4V |
| 2330 | 4822 124 23237 | 22µF 6,3V |
| 2331 | 2238 586 59812 | 100nF +80-20% Y5V 50V |
| 2332 | 4822 124 80151 | 47µF 16V |
| 2333 | 3198 017 44740 | 470nF Y5V 10V |
| 2334 | 4822 126 14315 | 390pF 5% NP0 50V |
| 2335 | 2238 586 59812 | 100nF +80-20% Y5V 50V |
| 2336 | 2238 586 59812 | 100nF +80-20% Y5V 50V |
| 2337 | 3198 017 41050 | 1µF Y5V 10V |
| 2338 | 4822 124 12084 | 1µF 20% 50V |
| 2343 | 3198 017 41050 | 1µF Y5V 10V |
| 2345 | 4822 124 81059 | 220µF 20% 4V |
| 2346 | 2238 586 59812 | 100nF +80-20% Y5V 50V |
| 2348 | 3198 017 41050 | 1µF Y5V 10V |
| 2400 | 2238 586 59812 | 100nF +80-20% Y5V 50V |
| 2401 | 5322 126 11578 | 1nF 10% X7R 50V |
| 2402 | 2238 586 59812 | 100nF +80-20% Y5V 50V |
| 2403 | 2238 586 59812 | 100nF +80-20% Y5V 50V |
| 2405 | 2238 586 59812 | 100nF +80-20% Y5V 50V |
| 2406 | 2238 586 59812 | 100nF +80-20% Y5V 50V |
| 2407 | 2238 586 59812 | 100nF +80-20% Y5V 50V |
| 2408 | 2238 586 59812 | 100nF +80-20% Y5V 50V |
| 2411 | 5322 126 11583 | 10nF 10% X7R 50V |
| 2500 | 4822 126 14241 | 330pF NP0 50V |
| 2501 | 4822 124 81059 | 220µF 20% 4V |
| 2502 | 4822 126 14491 | 2,2µF 10V |
| 2503 | 2222 867 15339 | 33pF 5% NP0 50V |
| 2511 | 3198 032 54110 | 4,7µF 20% 20V |
| 2515 | 4822 126 14238 | 2,2nF X7R 50V |
| 2516 | 4822 126 14247 | 1,5nF X7R 50V |
| 2520 | 2238 586 59812 | 100nF +80-20% Y5V 50V |
| 2522 | 4822 126 13883 | 220pF 5% 50V |
| 2523 | 2238 586 59812 | 100nF +80-20% Y5V 50V |
| 2524 | 4822 126 13883 | 220pF 5% 50V |
| 2525 | 2020 004 90283 | 10µF 20% 10V |
| 2526 | 3198 017 41050 | 1µF Y5V 10V |
| 2527 | 3198 032 54110 | 4,7µF 20% 20V |
| 2528 | 4822 126 14238 | 2,2nF X7R 50V |

ELECTRICAL PARTSLIST - COMBI BOARD**- CAPACITORS -**

| | | |
|------|----------------|-----------------------|
| 2529 | 4822 126 14247 | 1,5nF X7R 50V |
| 2530 | 3198 017 41050 | 1µF Y5V 10V |
| 2531 | 4822 126 14241 | 330pF NP0 50V |
| 2532 | 4822 124 81059 | 220µF 20% 4V |
| 2533 | 4822 126 14491 | 2,2µF 10V |
| 2534 | 2222 867 15339 | 33pF 5% NP0 50V |
| 2535 | 3198 017 41050 | 1µF Y5V 10V |
| 2536 | 4822 124 81058 | 47µF 20% 4V |
| 2537 | 2238 586 59812 | 100nF +80-20% Y5V 50V |
| 2538 | 3198 032 28210 | 220µF 20% 6,3V |

- RESISTORS -

| | | |
|------|----------------|-----------------|
| 3100 | 4822 051 30008 | 0R JUMPER |
| 3101 | 4822 051 30008 | 0R JUMPER |
| 3102 | 4822 051 30008 | 0R JUMPER |
| 3103 | 4822 051 30008 | 0R JUMPER |
| 3104 | 4822 051 30103 | 10K 5% 0,062W |
| 3105 | 4822 051 30103 | 10K 5% 0,062W |
| 3106 | 4822 117 13608 | 4,7R 5% 0,0016W |
| 3107 | 4822 051 30103 | 10K 5% 0,062W |
| 3108 | 4822 051 30103 | 10K 5% 0,062W |
| 3109 | 4822 051 30223 | 22K 5% 0,062W |
| 3110 | 4822 051 30222 | 2,2K 5% 0,062W |
| 3112 | 4822 051 30154 | 150K 5% 0,062W |
| 3113 | 4822 051 30472 | 4,7K 5% 0,062W |
| 3114 | 4822 051 30332 | 3,3K 5% 0,062W |
| 3115 | 4822 051 30152 | 1,5K 5% 0,062W |
| 3118 | 4822 051 30102 | 1K 5% 0,062W |
| 3119 | 4822 117 13632 | 100K 1% 0,62W |
| 3120 | 4822 051 30008 | 0R JUMPER |
| 3121 | 4822 051 30008 | 0R JUMPER |
| 3123 | 2322 704 62208 | 2,2R 1% |
| 3200 | 4822 051 30474 | 470K 5% 0,062W |
| 3201 | 4822 051 30474 | 470K 5% 0,062W |
| 3202 | 4822 051 30474 | 470K 5% 0,062W |
| 3203 | 4822 051 30474 | 470K 5% 0,062W |
| 3204 | 4822 051 30102 | 1K 5% 0,062W |
| 3205 | 4822 051 30102 | 1K 5% 0,062W |
| 3206 | 4822 051 30102 | 1K 5% 0,062W |
| 3207 | 4822 051 30102 | 1K 5% 0,062W |
| 3208 | 4822 051 30102 | 1K 5% 0,062W |
| 3209 | 4822 051 30102 | 1K 5% 0,062W |
| 3210 | 4822 051 30681 | 680R 5% 0,062W |
| 3211 | 4822 117 12971 | 15R 5% 0,62W |
| 3212 | 2322 704 62208 | 2,2R 1% |
| 3214 | 4822 051 30222 | 2,2K 5% 0,062W |
| 3215 | 4822 051 30151 | 150R 5% 0,062W |

- RESISTORS -

| | | |
|------|----------------|---------------------|
| 3216 | 4822 051 30563 | 56K 5% 0,062W |
| 3217 | 4822 051 30683 | 68K 5% 0,062W |
| 3218 | 4822 051 30393 | 39K 5% 0,062W |
| 3219 | 4822 051 30109 | 10R 5% 0,062W |
| 3221 | 4822 051 30109 | 10R 5% 0,062W |
| 3303 | 5322 117 13028 | 12K 1% 0,063W |
| 3305 | 4822 117 12706 | 10K 1% 0,063W |
| 3306 | 4822 051 30223 | 22K 5% 0,062W |
| 3307 | 4822 117 13632 | 100K 1% 0,62W |
| 3308 | 5322 117 13022 | 22K 1% 0,063W |
| 3309 | 5322 117 13022 | 22K 1% 0,063W |
| 3310 | 4822 051 30154 | 150K 5% 0,062W |
| 3311 | 4822 051 30103 | 10K 5% 0,062W |
| 3312 | 2122 551 00033 | VDR 1MA/5V5 MAX 19V |
| 3330 | 4822 117 13632 | 100K 1% 0,62W |
| 3331 | 4822 051 30103 | 10K 5% 0,062W |
| 3332 | 4822 051 30333 | 33K 5% 0,062W |
| 3333 | 4822 117 12968 | 820R 5% 0,62W |
| 3334 | 4822 117 12902 | 8,2K 1% 0,063W |
| 3335 | 2322 702 70278 | 2,7R 5% |
| 3336 | 2322 702 70278 | 2,7R 5% |
| 3337 | 4822 117 12925 | 47K 1% 0,063W |
| 3338 | 3198 021 32250 | 2,2M 5% |
| 3339 | 4822 051 30474 | 470K 5% 0,062W |
| 3340 | 4822 117 12925 | 47K 1% 0,063W |
| 3341 | 4822 051 30474 | 470K 5% 0,062W |
| 3342 | 4822 051 30474 | 470K 5% 0,062W |
| 3345 | 4822 051 30392 | 3,9K 5% 0,063W |
| 3346 | 4822 051 30223 | 22K 5% 0,062W |
| 3352 | 2322 704 62208 | 2,2R 1% RC22H |
| 3353 | 4822 051 30101 | 100R 5% 0,062W |
| 3354 | 4822 051 30101 | 100R 5% 0,062W |
| 3355 | 4822 051 30332 | 3,3K 5% 0,062W |
| 3356 | 4822 051 30471 | 470R 5% 0,062W |
| 3357 | 4822 051 30471 | 470R 5% 0,062W |
| 3359 | 4822 117 12925 | 47K 1% 0,063W |
| 3402 | 4822 051 30334 | 330K 5% 0,062W |
| 3403 | 3198 021 32250 | 2,2M 5% |
| 3404 | 4822 051 30103 | 10K 5% 0,062W |
| 3405 | 4822 051 30474 | 470K 5% 0,062W |
| 3406 | 4822 051 30334 | 330K 5% 0,062W |
| 3407 | 4822 051 30105 | 1M 5% 0,062W |
| 3408 | 4822 051 30105 | 1M 5% 0,062W |
| 3409 | 3198 021 32250 | 2,2M 5% |
| 3410 | 3198 021 32250 | 2,2M 5% |
| 3411 | 4822 051 30102 | 1K 5% 0,062W |
| 3412 | 4822 051 30102 | 1K 5% 0,062W |
| 3413 | 4822 117 12891 | 220K 1% |
| 3414 | 4822 117 12891 | 220K 1% |
| 3415 | 4822 117 13632 | 100K 1% 0,62W |

ELECTRICAL PARTSLIST - COMBI BOARD**- RESISTORS -**

| | | |
|------|----------------|----------------|
| 3416 | 4822 117 13632 | 100K 1% 0,62W |
| 3417 | 4822 117 12891 | 220K 1% |
| 3418 | 4822 051 30682 | 6,8K 5% 0,062W |
| 3419 | 4822 051 30682 | 6,8K 5% 0,062W |
| 3420 | 4822 117 13632 | 100K 1% 0,62W |
| 3421 | 4822 051 30682 | 6,8K 5% 0,062W |
| 3423 | 4822 117 13632 | 100K 1% 0,62W |
| 3424 | 4822 051 30008 | OR JUMPER |
| 3425 | 4822 051 30103 | 10K 5% 0,062W |
| 3426 | 4822 051 30103 | 10K 5% 0,062W |
| 3428 | 4822 051 30102 | 1K 5% 0,062W |
| 3429 | 4822 117 12891 | 220K 1% |
| 3430 | 4822 117 12925 | 47K 1% 0,063W |
| 3431 | 4822 051 30223 | 22K 5% 0,062W |
| 3432 | 4822 117 12925 | 47K 1% 0,063W |
| 3433 | 4822 117 12891 | 220K 1% |
| 3434 | 4822 051 30109 | 10R 5% 0,062W |
| 3435 | 4822 051 30109 | 10R 5% 0,062W |
| 3437 | 4822 051 30008 | OR JUMPER |
| 3438 | 4822 051 30472 | 4,7K 5% 0,062W |
| 3439 | 4822 051 30008 | OR JUMPER |
| 3440 | 4822 051 30008 | OR JUMPER |
| 3500 | 4822 051 30472 | 4,7K 5% 0,062W |
| 3501 | 4822 051 30123 | 12K 5% 0,062W |
| 3502 | 3198 021 32250 | 2,2M 5% |
| 3503 | 4822 117 12971 | 15R 5% 0,62W |
| 3505 | 4822 051 30472 | 4,7K 5% 0,062W |
| 3506 | 4822 051 30683 | 68K 5% 0,062W |
| 3507 | 4822 051 30331 | 330R 5% 0,062W |
| 3508 | 4822 051 30103 | 10K 5% 0,062W |
| 3510 | 4822 051 30681 | 680R 5% 0,062W |
| 3511 | 4822 051 30681 | 680R 5% 0,062W |
| 3513 | 4822 051 30474 | 470K 5% 0,062W |
| 3514 | 4822 117 12139 | 22R 5% 0,062W |
| 3515 | 2322 702 60184 | 180K 5% |
| 3517 | 4822 051 30331 | 330R 5% 0,062W |
| 3518 | 4822 051 30474 | 470K 5% 0,062W |
| 3519 | 4822 117 13632 | 100K 1% 0,62W |
| 3521 | 4822 117 13632 | 100K 1% 0,62W |
| 3522 | 4822 051 30103 | 10K 5% 0,062W |
| 3524 | 4822 051 30102 | 1K 5% 0,062W |
| 3525 | 4822 117 13632 | 100K 1% 0,62W |
| 3526 | 4822 051 30183 | 18K 5% 0,062W |
| 3530 | 4822 051 30102 | 1K 5% 0,062W |
| 3534 | 4822 117 13632 | 100K 1% 0,62W |
| 3535 | 4822 051 30682 | 6,8K 5% 0,062W |
| 3539 | 4822 117 12139 | 22R 5% 0,062W |
| 3542 | 4822 117 13632 | 100K 1% 0,62W |
| 3543 | 4822 051 30681 | 680R 5% 0,062W |
| 3544 | 4822 051 30681 | 680R 5% 0,062W |

- RESISTORS -

| | | |
|------|----------------|----------------|
| 3545 | 4822 051 30331 | 330R 5% 0,062W |
| 3546 | 4822 051 30472 | 4,7K 5% 0,062W |
| 3547 | 4822 051 30472 | 4,7K 5% 0,062W |
| 3548 | 3198 021 32250 | 2,2M 5% |
| 3549 | 4822 117 12971 | 15R 5% 0,62W |
| 3551 | 4822 051 30123 | 12K 5% 0,062W |
| 3552 | 4822 051 30683 | 68K 5% 0,062W |
| 3553 | 4822 051 30331 | 330R 5% 0,062W |
| 3554 | 4822 051 30103 | 10K 5% 0,062W |
| 3555 | 2322 702 60184 | 180K 5% |
| 3556 | 4822 117 13632 | 100K 1% 0,62W |
| 3557 | 4822 117 13632 | 100K 1% 0,62W |
| 3558 | 4822 117 13632 | 100K 1% 0,62W |
| 3559 | 4822 051 30109 | 10R 5% 0,062W |
| 4001 | 4822 051 30008 | OR JUMPER |
| 4002 | 4822 051 30008 | OR JUMPER |

- COILS & FILTERS -

| | | |
|------|----------------|--------------|
| 5300 | 4822 158 10525 | LAL 04T 331K |
| 5301 | 4822 157 50964 | 100M μ H |
| 5303 | 4822 158 10525 | LAL 04T 331K |

- DIODES -

| | | |
|------|----------------|--------------------------|
| 6302 | 9322 128 70685 | DIO REC SM SS14 (GI00) R |
| 6304 | 4822 130 11416 | PDZ6,8B |
| 6401 | 4822 130 11397 | BAS316 |
| 6402 | 4822 130 11416 | PDZ6,8B |
| 6403 | 4822 130 11416 | PDZ6,8B |
| 6404 | 4822 130 11416 | PDZ6,8B |
| 6405 | 4822 130 11416 | PDZ6,8B |
| 6406 | 4822 130 11416 | PDZ6,8B |
| 6407 | 4822 130 11416 | PDZ6,8B |
| 6500 | 5322 130 34331 | BAV70 |
| 6501 | 4822 130 11397 | BAS316 |
| 6502 | 4822 130 11551 | UDZS10B |
| 6503 | 5322 130 34331 | BAV70 |

- IC & TRANSISTORS -

| | | |
|------|----------------|-------------------|
| 7100 | 5322 130 60123 | BC807-40 |
| 7101 | 9322 182 66671 | AN8399SA |
| 7103 | 5322 130 60159 | BC846B |
| 7200 | 9322 175 89668 | MSM51V17405F-60SJ |
| 7201 | 9322 182 62671 | MN662786SB |
| 7202 | 9322 175 89668 | MSM51V17405F-60SJ |
| 7300 | 9322 186 76671 | AN41502 |
| 7301 | 5322 130 61569 | BC868 |
| 7303 | 4822 130 42615 | BC817-40 |
| 7304 | 4822 130 60142 | BC869 |

ELECTRICAL PARTSLIST - COMBI BOARD**- IC & TRANSISTORS -**

| | | |
|------|----------------|---------------|
| 7306 | 4822 130 60373 | BC856B |
| 7307 | 5322 130 60159 | BC846B |
| 7309 | 5322 130 60123 | BC807-40 |
| 7310 | 5322 130 60159 | BC846B |
| 7311 | 4822 130 60142 | BC869 |
| 7312 | 5322 130 60159 | BC846B |
| 7313 | 5322 130 60159 | BC846B |
| 7401 | 5322 130 60159 | BC846B |
| 7402 | 5322 130 60159 | BC846B |
| 7403 | 4822 130 60373 | BC856B |
| 7404 | 5322 130 60159 | BC846B |
| 7405 | 3140 110 51730 | MCU MN101C39C |
| 7406 | 4822 130 60373 | BC856B |
| 7407 | 4822 130 60373 | BC856B |
| 7500 | 4822 209 33165 | TDA1308T/N1 |
| 7501 | 4822 130 42615 | BC817-40 |
| 7503 | 4822 130 60373 | BC856B |
| 7506 | 5322 130 60123 | BC807-40 |
| 7508 | 4822 130 42615 | BC817-40 |
| 7510 | 5322 130 60159 | BC846B |
| 7511 | 5322 130 60159 | BC846B |
| 7512 | 4822 130 42615 | BC817-40 |
| 7513 | 4822 130 42615 | BC817-40 |
| 7515 | 5322 130 60159 | BC846B |

Note: Only these parts mentioned in the list are normal service parts.